



ALBED

MILANO 1964



archibook

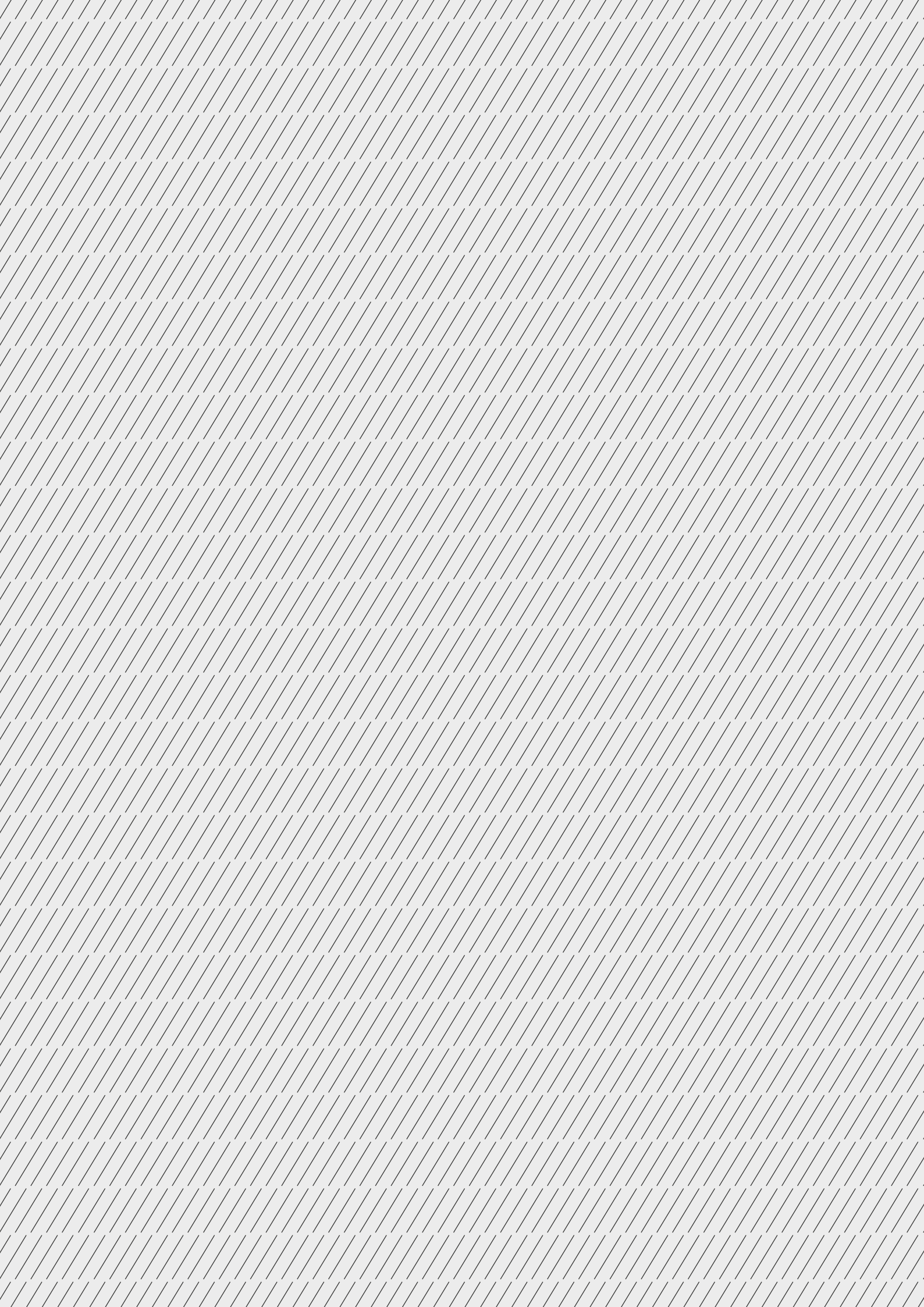

**Porte Battenti /
Scomparsa / 6**

level / 8
ring / 10
blow / 12
integra / 14
next / 18
and / 20
ri-trait / 22
ri-trait 8b / 24
prima / 26
quadra / 28
beat / 32
dot / 34

sail / 36
boisé / 38
céline / 40
quies / 42

**Porte
Scorrevoli / 52**

and / 54
ri-trait / 56
ri-trait 8b / 58
prima / 60
quadra / 62
beat / 66
quinta / 68
dot / 72
sail / 74
céline / 76

**Pareti
divisorie / 84**
all ways / 86
céline / 90

Cabine Armadio / 94

ri-vista / 96
solo / 100

Complementi / 108
vista girevole / 110
line / 112
nile / 116

about us



Albed, non solo porte. Progettare gli ambienti con trasparenze e giochi di luce, separare ma non dividere, dividere ma non nascondere, nascondere ma con visibile bellezza; ecco lo scopo della nuova collezione Albed: dividere gli spazi assecondando e valorizzando l'architettura. Rispondere alle esigenze progettuali diventa da oggi più semplice grazie all'uso di materiali come alluminio, cristalli ed essenze, che conferiscono leggerezza e luminosità a tutti gli ambienti. Porte e divisori, non più elementi secondari ma veri protagonisti dello spazio.

Albed, not just doors. To divide rooms by playing on light and transparency, to separate without cutting one space off from the next, to divide without hiding and conceal with visible beauty. This is the new purpose of doors and partitions: to define spaces without "imprisoning" them. This becomes easy thanks to materials like aluminium and crystal glass, which give interiors a touch of lightness and radiance. Doors and partitions, no longer secondary furnishings, become important elements in interiors.



Albed, bien plus que des portes. Diviser les pièces avec transparence et avec des jeux de lumière, séparer mais pas diviser, diviser mais pas cacher, cacher mais avec une beauté apparente, tel est le nouvel objectif des cloisons et des portes: définir des espaces sans les «emprisonner». La réussite de cette entreprise devient simple grâce aux nouveaux matériaux tels que l'aluminium et le verre, qui donnent de la légèreté et de la luminosité à toutes les pièces. Les portes et cloisons ne sont plus des éléments secondaires mais jouent un rôle de première importance dans l'espace.

Albed, nicht nur Türen. Die Unterteilung von Räumen mit Transparenzen und Lichtspielen - absondern, aber nicht teilen, teilen, aber nicht verbergen, verbergen, aber mit sichtbarer Schönheit - das ist der neue Zweck von Raumteilern und Türen: die Räumlichkeiten festlegen, ohne sie einzusperren". Diesem Zweck zu entsprechen ist nicht schwer dank der Verwendung von Materialien wie Aluminium und Glas, die allen Räumen Leichtigkeit und Helle verleihen. Türen und Raumteiler - nicht mehr zweitrangige Elemente, sondern wahre Protagonisten des Raums.

Albed, no sólo puertas. Proyectar los ambientes con transparencias y juegos de luz, separar pero no dividir, dividir pero no esconder, esconder pero con belleza visible; he aquí el nuevo objetivo de la colección de paredes divisorias y puertas: definir los espacios sin atraparlos. Responder a esta necesidad de diseño llega a ser sencillo gracias al uso de materiales como el aluminio, los cristales y las maderas, que confieren ligereza y luminosidad a todos los ambientes. Las puertas y las paredes divisorias ya no son elementos secundarios, sino los verdaderos protagonistas del espacio.

progetti

GUCCI HQ

Milano

GUCCI HQ

Firenze

BULGARI HQ

Valenza

KYTON

Milano

JACOB COHEN

Milano

ALDO COPPOLA

Milano

MOSCHINO

Milano

IRIS CERAMICHE HQ

Fiorano Modenese

ARIOSTEA HQ

Castellarano

ASSICURAZIONI LE GENERALI

Milano

FC INTERNAZIONALE HQ

Milano

VERSACE HQ

Milano

SHOWROOM ASTON MARTIN

Mondo

MPR CLIVEDALE

London

BENI STABILI

Milano

HOTEL BEST WESTERN CRISTALLO

Rovigo

HOTEL MISINCU

Corse

HOTEL KALIMERA KRITI

Creta



TERRAZZA TRIENNALE

Location: Milan, Italy
Client: Triennale
Principal Use: Restaurant
Products ALBED: Custom made doors
Customized products: NEXT



GUESS

Location: Bioggio, Switzerland
Client: Guess Group
Principal Use: Headquarter
Products ALBED: Doors and partitions
Customized products: NEXT and ALL WAYS



D'LEEDON

Location: Singapore
Design Architect: Zaha Hadid
Principal Use: Residential
Products ALBED: Wardrobes and Doors
Customized products: SOLO



ALFA ROMEO

Location: Arese, Italy
Client: Alfa Romeo
Principal Use: Museum
Products ALBED: Custom made doors
Customized products: SAIL and PRIMA



KINDER GARDEN

Location: Milan, Italy
Principal Use: Kinder garden
Products ALBED: Custom made doors and sliding doors
Customized products: QUADRA and NEXT



PALAZZO MONTEMARTINI

Location: Rome, Italy
Design Architect: King Roselli
Principal Use: Hotel
Products ALBED: Doors, sliding doors and partitions
Customized products: DOT



porte

battenti e scomparsa

Ci piace credere che ogni passaggio abbia un valore ed è forse per questo che per noi una porta oltre ad essere un elemento pratico rappresenta un segno.

We like to think that each passage has its own value and this is why we believe that a door is not only a practical element but also a mark.

Nous aimons croire que chaque passage revêt une valeur et c'est peut-être la raison pour laquelle, selon nous, une porte n'est pas seulement un élément pratique, mais aussi un signe.

Wir sind der festen Überzeugung, dass jeder Durchgang seine Bedeutung besitzt, weshalb eine Tür für uns nicht nur ein praktischer Bestandteil der Wohnung ist, sondern auch Zeichen setzt.

Nos gusta creer que cada paso tiene un valor, y es quizás por esta razón que para nosotros una puerta, además de ser un elemento práctico, también representa un signo.

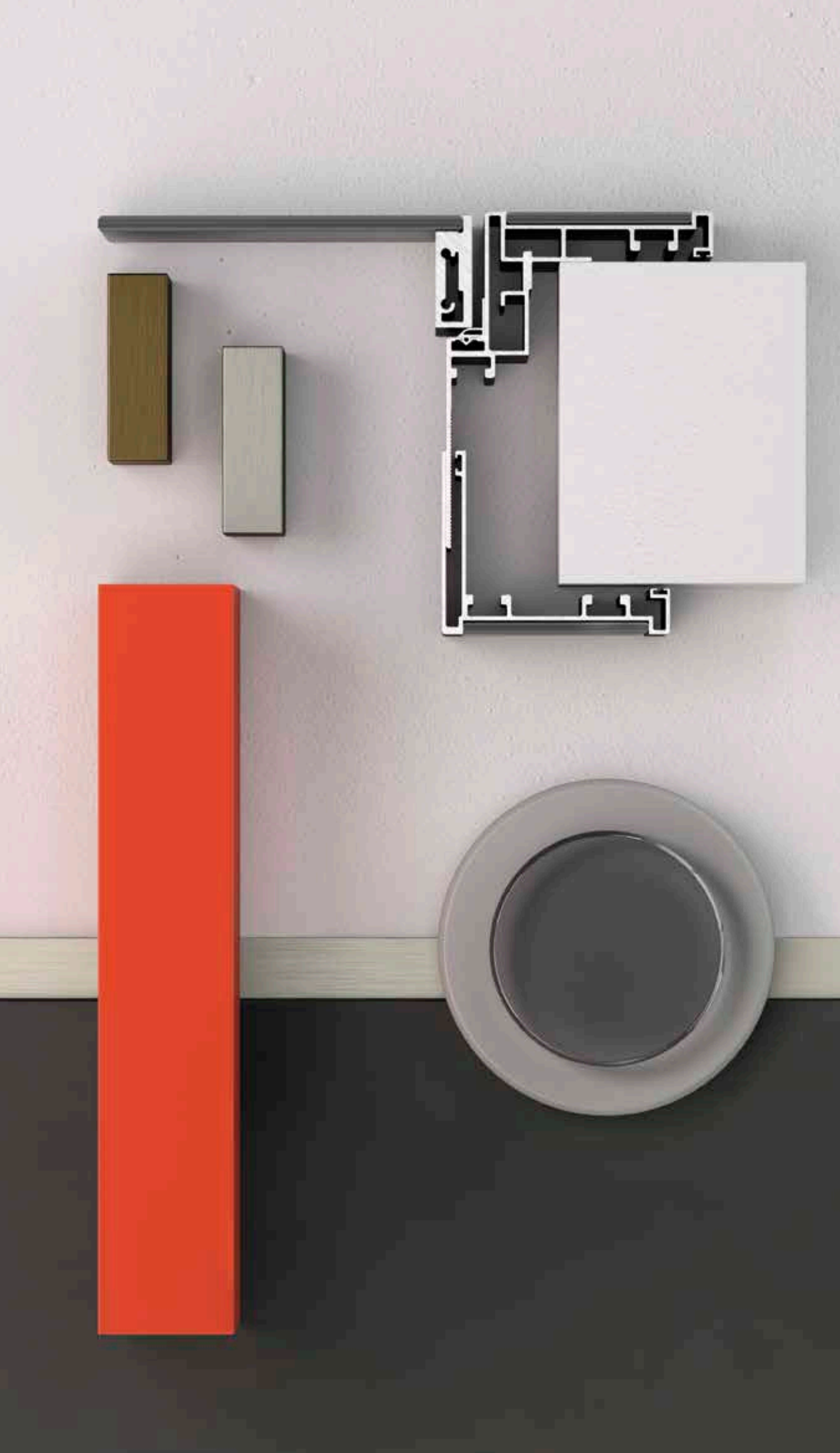

level

Designed by: Paolo Cappello

Typology: Porta battente / Hinged door /
Porte battante / Drehtür / Puerta batiente

Dalla collaborazione con il designer Paolo Cappello e ALBED nasce LEVEL, una porta battente dalle linee molto essenziali ma con una particolarità che la rende unica: quando è chiusa il pannello ricopre interamente il telaio.

The LEVEL hinged door, with very basic and special feature that makes it unique, when it is closed the frame is completely covered by the panel, thanks to the cooperation with the designer Paolo Cappello and ALBED.

De la collaboration avec le designer Paolo Cappello et ALBED naît LEVEL, une porte battante aux lignes très essentielles mais possédant une particularité qui la rend unique : lorsqu'elle est fermée, le panneau recouvre entièrement le châssis.

Aus der Zusammenarbeit zwischen dem Designer Paolo Cappello und ALBED ist LEVEL entstanden, eine Drehtür mit schlichten Linien, die sich durch eine Besonderheit auszeichnet: wenn sie geschlossen ist, wird der Rahmen komplett durch die Türfüllung bedeckt.

De la colaboración con el diseñador Paolo Cappello y ALBED nace la puerta batiente LEVEL, con líneas muy esenciales pero con una particularidad que la hace única: cuando la puerta está cerrada cubre completamente la jamba.





porte battenti / scomparsa

08 / 09

level

ring

Designed by: Karim Rashid

Typology: Porta battente / Hinged door /
Porte battante / Drehtür / Puerta batiente

Spingersi oltre al limite dell'immaginazione: RING è l'INNOVAZIONE in grado di stupirci ancora una volta; la maniglia è un foro circolare che nasconde la SOFISTICATA tecnologia di apertura.

Venturing beyond the limits of imagination: RING is INNOVATION capable of surprising us once again; the handle is a circular hole hiding a SOPHISTICATED opening technology.

Aller au-delà des limites de l'imagination: RING est l'INNOVATION capable de nous étonner encore une fois; la poignée est un trou circulaire qui cache une technologie d'ouverture SOPHISTIQUEE.

Jenseits der Vorstellungskraft: RING ist eine INNOVATION, die in Staunen versetzt; der Griff befindet sich in einem runden Loch, das einen AUSGEKLÜGELTEN Öffnungsmechanismus enthält.

Ir más allá del límite de la imaginación: RING es la INNOVACIÓN capaz de sorprendernos una vez más; el tirador es un agujero circular que esconde la SOFISTICADA tecnología de apertura.

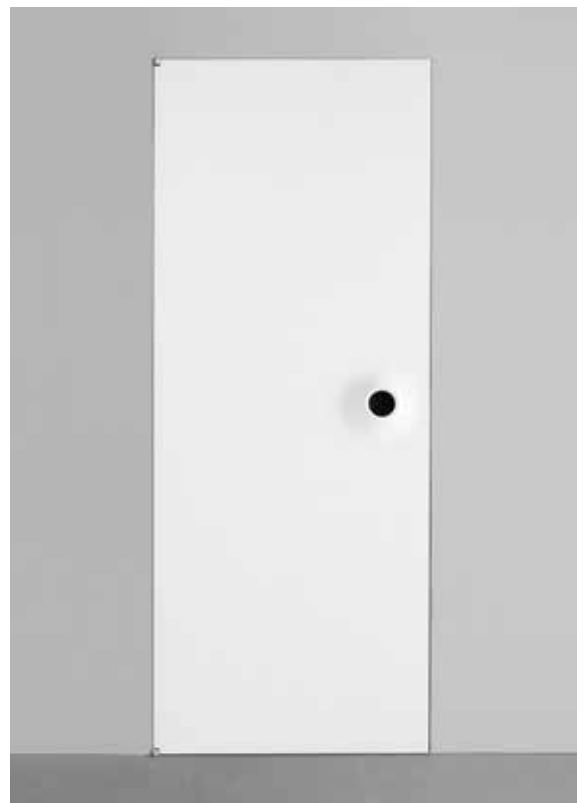



① Stipiti a 45° | Jams 45° | Montants à 45° | Türstockverkleidung 45° | Jambas en 45°

② Maniglia incassata | Recessed handle | Poignée encastrée | Griffmulde | Tirador empotrado

blow

Designed by: Karim Rashid

Typology: Porta battente / Hinged door /
Porte battante / Drehtür / Puerta batiente

La presa verticale della maniglia diventa un'operazione naturale. Il pannello non è più piano, ma prende forma disegnando un'onda e la maniglia è la gola al suo interno.

The vertical grip of the handle becomes a natural operation. The door panel is no longer flat, its form shapes into a wave and the handle is its inside groove.

La prise verticale de la poignée se fait de manière simple et naturelle. Le panneau n'est pas plat, il prend la forme d'une onde dans le creux de laquelle est placée la poignée.

Das vertikale Fassen des Griffes wird zu einer natürlichen Handlung. Das Türblatt ist nicht mehr flach, es nimmt die Gestalt an und zeichnet eine Welle und der Griff ist in der Kehle innen.

El agarre vertical del tirador vuelve a ser una operación natural. El panel ya no es plano, sino toma la forma diseñando una onda y la manilla queda alojada en su interior.





porte battenti / scomparsa

12 / 13

blow

integra

Designed by: CRS albed

Typology: Porta battente / Hinged door /
Porte battante / Drehtür / Puerta batiente

Integra è un semplice segno, uniforme e ininterrotto, un'ombra quasi invisibile su una parete che si apre per trasformarsi in porta, definita nei suoi contorni semplicemente dalla luce che attraversa i due ambienti che divide. Il pannello, spesso quanto il muro, quando chiuso diventa a filo del muro da entrambi i lati.

Integra is a uniform and continuous simple sign, a quite invisible shadow on a wall, which opens to become a door, outlined by the light that passes through the two environments that it divides. The panel, as thick as the wall, when closed, becomes flush with the wall on both sides.

Integra est un signe simple, uniforme et ininterrompu, une ombre presque invisible sur un mur qui s'ouvre pour se transformer en porte, dont les contours sont tout simplement définis par la lumière qui traverse les deux espaces qu'elle sépare. Le panneau, de même épaisseur que le mur, se positionne au ras du mur des deux cotés lorsqu'il est fermé.

Integra zeichnet sich durch ihre einfache, gleichmäßige und durchgehende Wirkung aus, ein beinahe unsichtbarer Schatten an der Wand, der sich öffnet und in eine Tür verwandelt. Ihr schlichter Umriss wird nur durch das Licht in den beiden Räumen nachgezeichnet, die durch die Tür getrennt werden. Paneel, dick als die Wand, als geschlossen, wird beidseitig wandbündig.

Integra es un signo sencillo, uniforme y continuo, una sombra casi invisible en la pared, que se abre para transformarse en una puerta, cuyos contornos se definen por la luz que atraviesa los dos ambientes que separa. La puerta, cuyo grosor es igual al muro, cuando está cerrada queda a ras de la pared por ambos los lados.



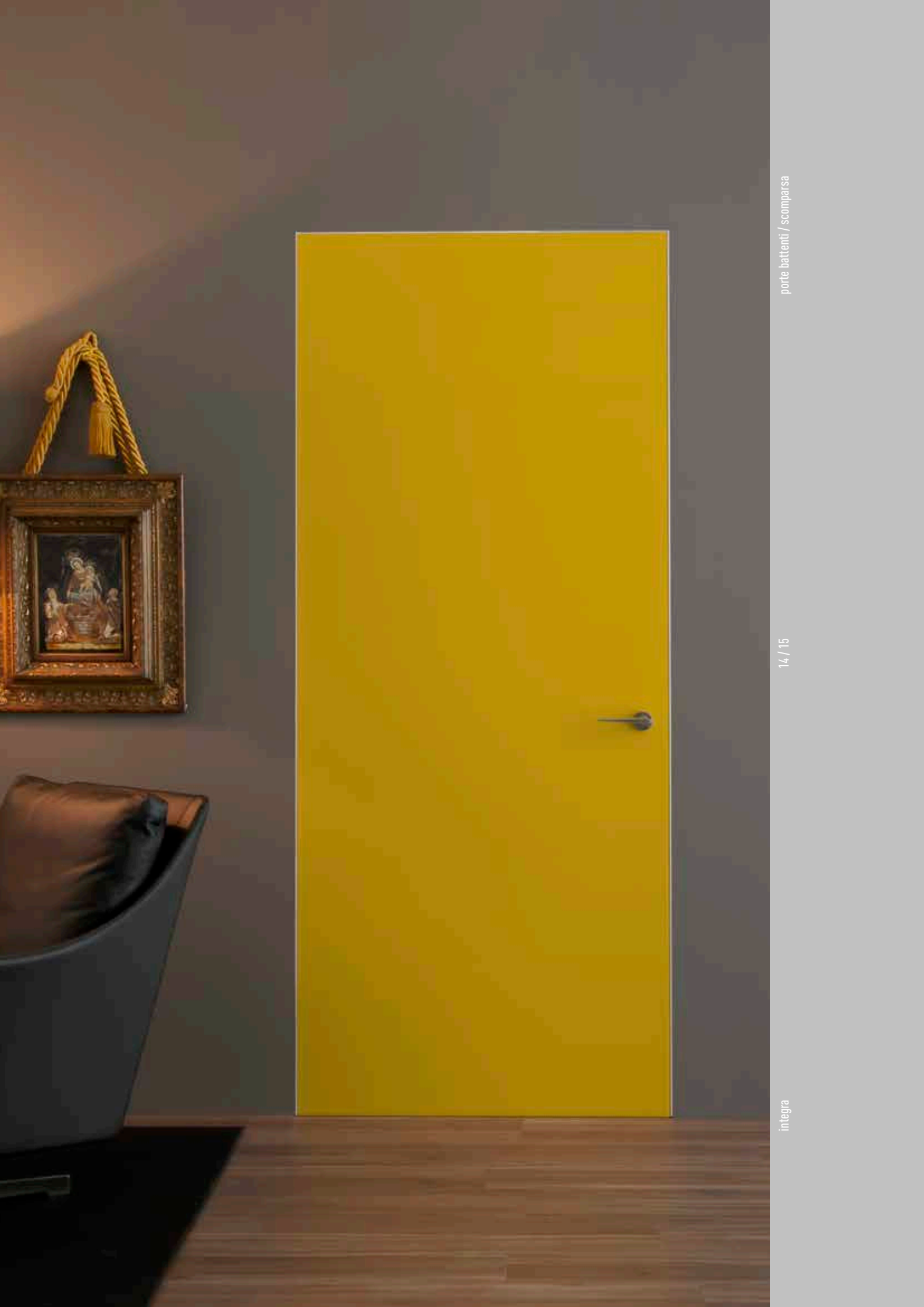





/ ① Telaio in alluminio | aluminum frame | cadre en aluminium | Aluminiumrahmen | marco de aluminio

/ ② Monitor integrato | Integrated monitor | Integrierter Monitor | Moniteur intégré | Monitor integrado

next

Designed by: CRS albed

Typology: Porta battente / Hinged door /
Porte battante / Drehtür / Puerta batiente

Meccanica ed estetica si fondono e danno vita ad una porta dalle mille interpretazioni, capace di rispondere alle esigenze progettuali senza dimenticare quelle tecniche legate al cantiere. Next EI30 certificata e resistente al fuoco.

Mechanics and aesthetics combine to produce a door with a thousand interpretations, able to fit into design requirements without forgetting the technical requirements related to the building site. Certified and fire resistant.

La mécanique et l'esthétique se fondent pour donner vie à une porte aux mille interprétations, en mesure de répondre à toutes les exigences du projet tout en tenant compte des exigences techniques liées au chantier. Certifiée résistante au feu.

Mechanik und Ästhetik gehen bei dieser Tür, die vielseitige Interpretationsmöglichkeiten bietet, eine gelungene Verbindung ein. Sie entspricht unterschiedlichsten Projektanforderungen, ohne dass dabei die bautechnischen Notwendigkeiten vernachlässigt werden. Zertifiziert und feuerbeständig.

Mecánica y estética se funden por dar vida a una puerta de mil interpretaciones, capaz de responder a las necesidades proyectuales sin olvidar aquellas técnicas ligadas a la obra. Certificada y resistente al fuego.



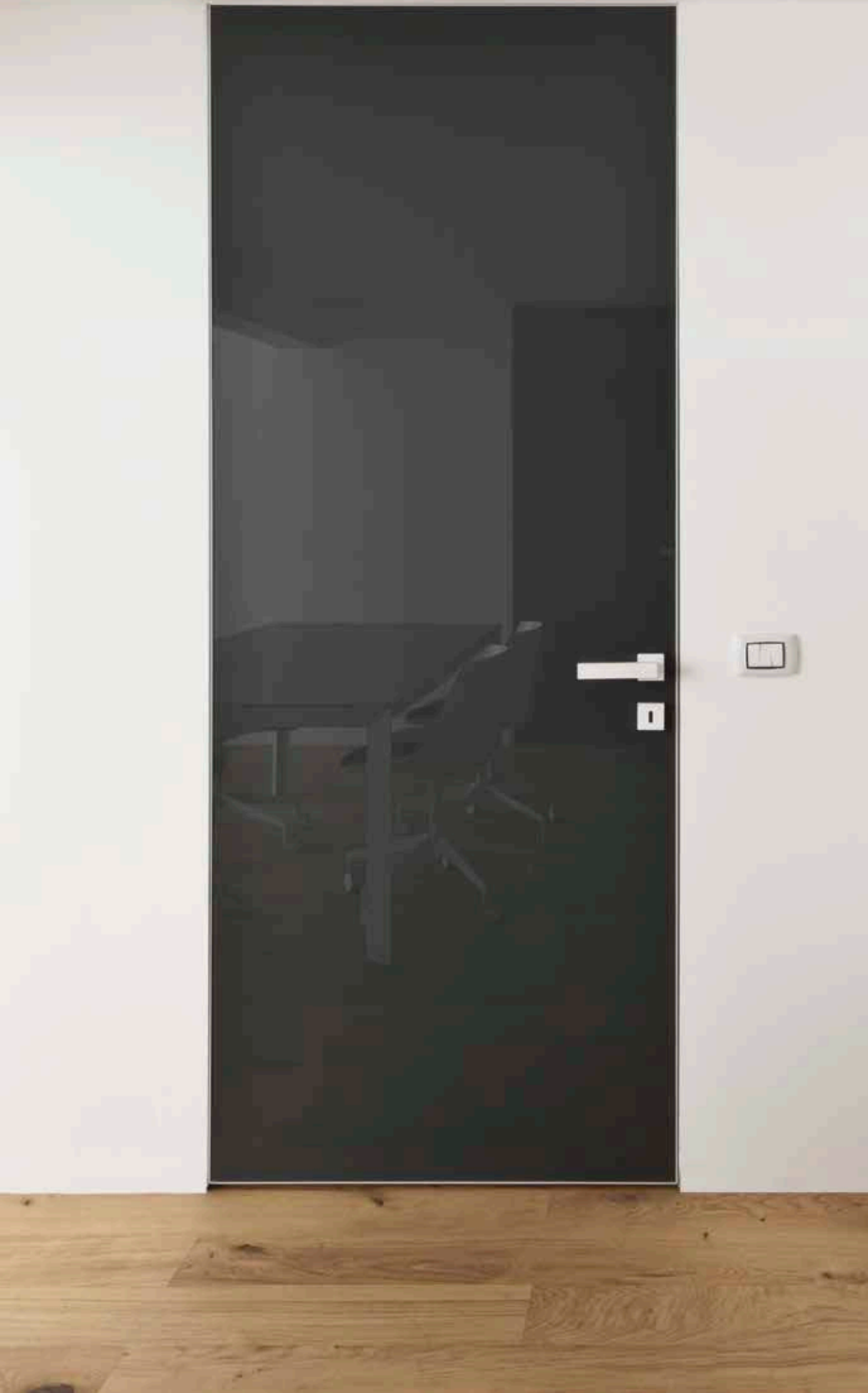

and

Designed by: CRS albed

Typology: Porta battente / Hinged door /
Porte battante / Drehtür / Puerta batiente

And battente, pannello laccato. La porta che nella sua semplicità racchiude le peculiarità del savoir faire. Accurata artigianalità nella lavorazione del legno, nel pannello e nello stipite.

Swing door And with lacquered panel. The simplicity of this door contains all the peculiarities of savoir faire. Careful craftsmanship in woodworking, panel door and jamb.

And battante, panneau verniés. La porte And dans sa simplicité embrasse tous les particularités du savoir-faire. Soin artisanal pour le travail du bois, pour les panneaux et les montants.

And Drehtür, lackiertes Paneel. Die Tür, die in ihrer Einfachheit, die Besonderheit von "savoir faire" enthält. Genaue Handwerkskunst in der Verarbeitung des Holzes, im Paneel und im Pfosten. Die Technologie versichert die Wandbündigkeit der Tür und erlaubt eine Öffnung sowohl zum Ziehen als auch zum Drücken.

Puerta batiente And con panel lacado. La puerta que en su sencillez incluye las peculiaridades del savoir faire. Precisión en el trabajo de la madera, de los paneles y de los marcos.





ri-trait

Designed by: CRS albed

Typology: Porta battente / Hinged door / Porte battante / Drehtür / Puerta batiente

Porta scomparsa | Pocket door | Porte à la galandage | Einschiebbare | Puerta escamotable

Il concept e l'identità del modello si racchiudono in una sola parola: leggerezza, ovvero la volontà di alleggerire le forme e i materiali e snellire l'insieme per un prodotto minimale. Così nasce Ri-Trait.

The concept and the identity of the model can be describes in one word: lightness. In a few more: that's the desire to lighten the structure and materials used, in order to streamline the product and create a truly minimalistic object. This is Ri-Trait.

Le concept et l'identité du modèle sont inclus dans un mot: légèreté, c'est à dire le désir d'alléger les formes et de matériaux et de rationaliser l'ensemble pour un produit minimal. Ainsi est né Ri-Trait.

Das Konzept und die Identität des Modells werden in einem einzigen Wort eingeschlossen: Leichtigkeit. Nämlich der Wunsch, die Formen und Materialien zu erleichtern und die Menge für eine minimale Produkt optimieren. So Ri-Trait geboren wurde.

El concepto y la identidad de la modelo están encerrados en una sola palabra: la ligereza. A saber, el deseo de aligerar las formas y materiales y racionalizar el conjunto de un producto mínimo. Así nació Ri-Trait.





① Pannello porta in vetro ardesia | Door panel in ardesia glass | Panneau porte en verre ardesia | Türpaneel in Glas Ardesia | Panel puerta en cristal ardesia

② Coprifi li personalizzabili | Customized finishing lists | Montants personnalisés | wahlweisen Verkleidungen | Tapetas personalizables

ri-trait 8b

Designed by: CRS albed

Typology: Porta battente / Hinged door /
Porte battante / Drehtür / Puerta batiente

Una collezione al di fuori delle mode e sempre attuale, che risponde ad ogni situazione e ogni principio di riconoscibilità.

An ever-current collection that defies fashion fads, and responds to every situation and every identification principle.

Une collection qui ne suit pas la mode mais qui est toujours actuelle et sait répondre à toutes les situations et principes de reconnaissabilité.

Eine aktuelle Kollektion, die jede Situation und jede Erkennbarkeit meistert.

Una colección fuera de las modas pero siempre actual, que responde a cada situación y a cada principio de reconocibilidad.





① Stipiti a 45° | Jambas 45° | Montants à 45° | Türstockverkleidung 45° | Jambas en 45°

② Profili e maniglia in alluminio anodizzato champagne | Profiles and handle in champagne anodized aluminium | Profils et poignée en aluminium anodisé champagne | Rahmen und Griff in Aluminium Champagne anodisiert | Perfil y maneta en aluminio anodizado champagne

prima

Designed by: CRS albed

Typology: Porta battente / Hinged door / Porte battante / Drehtür / Puerta batiente

Porta scomparsa | Pocket door | Porte à la galandage | Einschiebbare | Puerta escamotable

La semplicità diventa protagonista della collezione, che si materializza nel sottile profilo delle strutture, per permettere con più agio il passaggio della luce, e per impreziosire gli ambienti che la ospitano.

The simplicity becomes the star of the collection, which is clearly shown by the slim profile of the structures, which allows the ease of passage of the light, and enriches all the ambiances around.

La simplicité devient le protagoniste de la collection, qui se matérialise dans le profil mince des structures, pour permettre de faciliter le passage de la lumière, et d'enrichir les environnements qui hébergent.

Die Einfachheit wird Hauptfigur der Kollektion, die im schlanken Profil der Strukturen verwirklicht wird, den Durchgang von Licht zu ermöglichen, und die Umgebungen zu bereichern.

La sencillez también es la estrella de la colección, que se materializa en el perfil delgado de las estructuras, para permitir una mayor facilidad el paso de la luz, y para enriquecer los ambientes que albergan.





① Profili e maniglia in alluminio anodizzato nero | Profiles and handle in black anodized aluminium | Profils et poignée en aluminium anodisé noir | Rahmen und Griff in Aluminium Schwarz anodisiert | Perfil y maneta en aluminio anodizado negro

② Pannello porta in vetro fumè acidato | Door panel in frosted fumè glass | Panneau porte en verre fumè anodisé | Türpaneel in Glas satiniert fumè | Panel puerta en cristal fumè ácido



quadra

Designed by: CRS albed

Typology: Porta battente / Hinged door / Porte battante / Drehtür / Puerta batiente

Porta scomparsa | Pocket door | Porte à la galandage | Einschiebbare | Puerta escamotable

Pulizia delle linee e geometria secca, per Quadra, una porta dove la tecnicità estetica dei profili diventa protagonista del segno progettuale.

Clean lines and geometric clarity define Quadra, a door with a technical profile that is perfect for dividing areas in which every furnishing element in the home is an important piece of decor.

Des lignes épurées et une géométrie brute pour Quadra, une porte aux profilés techniques qui répond parfaitement aux besoins en termes de séparation des pièces, lorsque chaque élément de la maison joue un rôle de protagoniste.

Saubere Linien und nüchterne Geometrie für Quadra, eine Tür mit technischen Profilen, um besser dem Anspruch auf Unterteilung solcher Räume zu entsprechen, in denen jedes Element der Wohnung eine vordergründige Rolle spielt.

Líneas limpias y geometría seca definen Quadra, una puerta con perfiles técnicos para adaptarse en la mejor manera a las exigencias de subdivisión de los ambientes, en los cuales cada elemento de la casa juega un papel de protagonista.





① Stipiti slim | Slim jambs | Montants slim | Slim Pfosten | Montantes slim

② Profili e maniglia in anodizzato bronzo | Profiles and handle in bronze anodized aluminium | Profils et poignée en aluminium anodisé bronze | Rahmen und Griff in Aluminium Bronze anodisiert | Perfil y maneta en aluminio anodizado bronce



① Quadra battente doppio vetro | Quadra swing door double glass | Quadra porte battante double verre | Quadra Drehtür Doppelglas |
Quadra batiente doble vidrio

② Coprifili personalizzabili | Customized finishing lists | Montants personnalisés | wahlweisen Verkleidungen | Tapetas personalizables



- ① Quadra corridoio doppia | Double door Quadra for building without counterframe | Quadra couloir double | Quadra Doppeldrehtür Flur | Quadra pasillo doble
- ② Finitura profili champagne e vetri extrachiaro | Champagne finishing profiles and extra-clear glasses | Profils champagne et verre extraclair | Ausführung Profile Champagne und Glas extra-hell | Acabado perfiles champagne y vidrios extraclaros

beat

Designed by: CRS albed

Typology: Porta battente / Hinged door / Porte battante / Drehtür / Puerta batiente
Porta scomparsa | Pocket door | Porte à la galandage | Einschiebbare | Puerta escamotable

Estetica. Tecnologia. Valore d'arredo. Queste sono le premesse della porta Beat e realizzano un obiettivo preciso: coniugare architettura e interior design, restituendo alla porta tutta la sua valenza di oggetto fondamentale nella gestione degli spazi.

Aesthetics. Technology. Value of furnishing. These are the basis for the Beat door and they achieve a precise objective: to match architecture and interior design, giving back to the door all of its value as a fundamental object in the management of spaces.

Esthétique. Technologie. Ameublement de qualité. Ces sont les intentions pour la porte Beat, qui réalise un objectif précis: conjuguer architecture et "intérieur design", en donnant à la porte tout son rôle d'objet fondamental dans la gestion de l'espace.

Ästhetik. Technologie. Wert der Einrichtung. Beat strebt ein präzises Ziel an: Architektur und Interior Design zu verbinden und dennoch die Bedeutung der Türe für die Organisation des Raums zu unterstreichen.

Estética. Tecnología. Valor del adorno. Estas son las premisas de la puerta Beat y realizan un objetivo preciso: conjugar arquitectura e interior design, devolviendo a la puerta su importancia de objeto fundamental en la gestión de los espacios.





① Stipiti a 45° | Jams 45° | Montants à 45° | Türstockverkleidung 45° | Jambas en 45°

② Pannello porta in vetro neve extrachiaro | Door panel in neve extrachiaro glass | Panneau porte en verre neve extrachiaro | Türpaneel in Glas neve extrachiaro | Panel puerta en cristal neve extrachiaro

dot

Designed by: CRS albed

Typology: Porta scomparsa | Pocket door | Porte à la galandage |
Einschiebbare | Puerta escamotable

La linearità nella sua forma più pura, quasi eterea, dove la forza della struttura è nascosta da un'immagine di totale leggerezza. Dot da movimento alla luce.

Linearity with the purest, almost ethereal, shape, where a sturdy structure is concealed with extreme lightness. Dot adds variety to light.

Avec sa forme linéaire très pure, presque éthérée, où la force de la structure se cache dans une apparence de légèreté totale, Dot donne mouvement à la lumière.

Einfachheit in ihrer reinsten Form, fast ätherisch, die Leichtigkeit des optischen Eindrucks lässt die Kraft der Struktur vergessen. Dot bewegt Licht.

La linealidad en su forma más pura, casi etérea, donde la fuerza de la estructura está escondida por una imagen de total ligereza. Dot da movimiento a la luz.

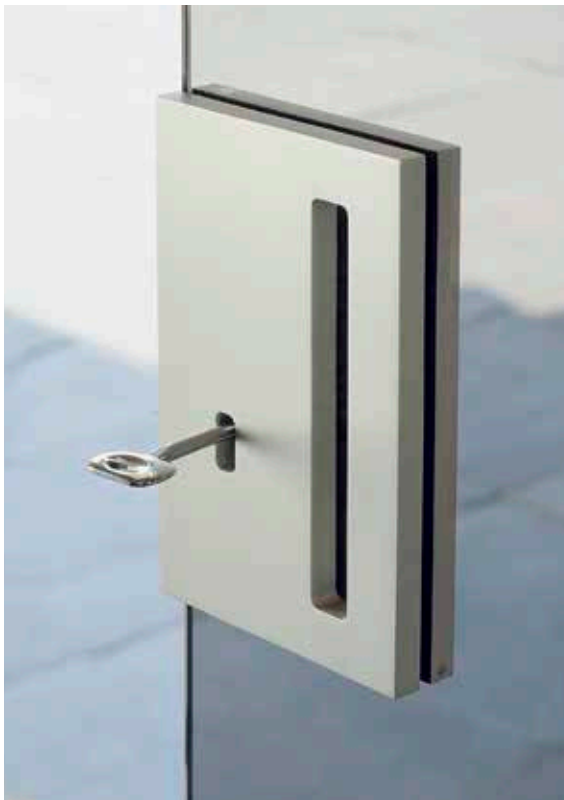



porte battenti / scomparsa

34 / 35

dot

① Stipiti a 45° | Jambes 45° | Montants à 45° | Türstockverkleidung 45° | Jambas en 45°

sail

Designed by: Paolo Bistacchi

Typology: Porta battente / Hinged door /
Porte battante / Drehtür / Puerta batiente

I movimenti silenziosi, sicuri, gesti che diventano quotidiani e che raccontano l'uso dello spazio. La porta battente Sail dà un impulso all'architettura nel segno di una perfetta integrazione stilistica e funzionale.

Silent movements, safe secure motions that become familiar and reveal the use of the space. The Sail hinged door adds a nice touch to the architecture, with its perfect stylistic and functional integration.

Des mouvements silencieux, fiables, des gestes quotidiens qui racontent l'utilisation de l'espace. La porte battante Sail donne une nouvelle impulsion à l'architecture avec l'intégration parfaite du style et de l'aspect fonctionnel.

Geräuscharmes und zuverlässiges Verschieben, bei täglicher Benutzung, das macht jeden Raum nutzbar. Die Drehtür Sail gibt der Architektur Impulse und ist eine perfekte, stilistische und zweckmäßige Ergänzung.

Los movimientos silenciosos y seguros, gestos cotidianos que cuentan el uso del espacio. La puerta batiente Sail da un impulso a la arquitectura en el signo de una perfecta integración estilística y funcional.





① Stipiti a 45° | Jams 45° | Montants à 45° | Türstockverkleidung 45° | Jambas en 45°

② Pannello porta in vetro dark grey | Door panel in dark grey glass | Panneau porte en verre dark grey | Türpaneel in Glas dark grey | Panel puerta en cristal dark grey

boisé

Designed by: Bettazzi + Percoco architetti

Typology: Porta battente / Hinged door /
Porte battante / Drehtür / Puerta batiente

Boisé è l'esplicita abbreviazione di boiserie e racconta di un progetto ideato per creare un sistema leggero e flessibile di porte a scomparsa, inserite per l'appunto in una boiserie.

Boisé is the abbreviation of boiserie. It is about a project specifically designed to create a flexible and light system of doors for cavity wall, exactly inserted in a boiserie.

Boisé est l'abréviation de boiserie. Il est un projet spécifiquement conçu pour créer un système souple et léger de portes pour murs creux, exactement insérées dans une boiserie.

Boisé ist die Abkürzung von Boiserie. Es handelt sich um ein Projekt konzipiert, speziell und flexibel um ein Lichtsystem von Türen für Hohlraumwand zu schaffen, genau in einem boiserie eingefügt.

Boisé es la abreviatura de boiserie. Se trata de un proyecto diseñado específicamente para crear un sistema flexible y ligero de las puertas de pared de la cavidad, que se inserta exactamente en una boiserie.





porte battenti / scomparsa

38 / 39

boisé

céline

Designed by: Paolo Festa

Typology: Porta battente / Hinged door / Porte battante / Drehtür / Puerta batiente
Porta scomparsa | Pocket door | Porte à la galandage | Einschiebbare | Puerta escamotable

Leggerezza, trasparenza, capacità di dividere e unire allo stesso tempo. Un progetto che prende spunto dalla partitura tipica degli ambienti giapponesi e allo stesso tempo si regola ispirandosi alle vetrate industriali dei primi del '900. Céline riporta la tradizione in un contesto contemporaneo.

Lightness, transparency, ability to divide and connect at the same time, that's all it is. A project that combines partitions typical of Japanese taste with industrial wall of glass from the early XX century. Céline brings tradition back into a contemporary contest.

Légèreté, transparence, capacité à diviser et à unir à la fois. Un projet qui s'inspire aux partitionnes typiques des environnements japonais et au même temps du vitrage industriel du début du XXème siècle. Céline ramène la tradition dans un contexte contemporain.

Leichtigkeit und Durchsichtigkeit, Trennungs- und Vereinigungsfähigkeit zur gleichen Zeit. Ein Projekt, dass sich an der typischen japanischen Szenerie orientiert und gleichzeitig von der industriellen Glasur des frühen 20. Jahrhunderts inspiriert wird. Céline bringt Tradition in einen zeitgenössischen Kontext zurück.

Ligereza, transparencia, capacidad de dividir y unir al mismo tiempo. Un proyecto que toma su ejemplo del ambiente típico japonés y al mismo tiempo está inspirado en el acristalamiento industrial de principio del siglo XX. Céline devuelve la tradición a un contexto contemporáneo.





porte battenti / scomparsa

40 / 41

céline

① Profili e maniglia in alluminio anodizzato champagne | Profiles and handle in champagne anodized aluminium | Profils et poignée en aluminium anodisé champagne | Rahmen und Griff in Aluminium Champagne anodisiert | Perfil y maneta en aluminio anodizado champagne

quies

Designed by: CRS Albed

Typology: Porta battente / Hinged door /
Porte battante / Drehtür / Puerta batiente

Tecnica e design si uniscono nel progetto Quies, una porta dalle alte prestazioni fonoisolanti che riduce il rumore tra le stanze mantenendo la trasparenza del vetro. Quies garantisce l'isolamento acustico grazie a specifici componenti che sigillano l'intero perimetro della porta.

Know-how and design combines together into Quies project, a door with high sound reducing abilities that reduce the noise between spaces while maintaining the transparency of the glass. Quies makes this possible thanks to high-tech components that seal up the whole surface of the door panel.

Le projet Quies associe technique et design, une porte à haute performance d'insonorisation qui réduit le bruit entre les pièces tout en maintenant la transparence du verre. Quies garantit une isolation acoustique grâce à des composants spécifiques qui scellent tout le périmètre de la porte.

Technik und Design vereinen sich im Quies-Projekt, einer Tür mit hoher Schalldämmleistung, die den Lärm zwischen den Räumen reduziert, aber die Transparenz des Glases beibehält. Quies garantiert die Schalldämmung dank spezieller Komponenten, die den gesamten Umfang der Tür abdichten.

La técnica y el diseño se unen en el proyecto Quies, una puerta con alta insonorización que reduce el ruido entre las habitaciones manteniendo la transparencia del vidrio. Quies garantiza un aislamiento acústico gracias a componentes específicos que sellan todo el perímetro de la puerta.



①

②

① Stipiti in alluminio | Frame in aluminum | Structure en aluminium | Rahmenstruktur in Aluminium | Estructura en aluminio

② Quies certificata 37 db | Quies certified 37 db | Quies certifiée 37 db | Quies Zertifiziert 37 db | Quies certificada 37 db

level

pag 8



Pianta |
Plan |
Plan |
Plan |
Planta

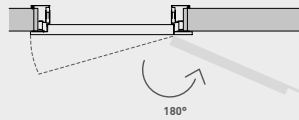

Sezione verticale |
Vertical section |
Section verticale |
Vertikalschnitt |
Sección vertical



ring

pag 10



Stipiti a 45° |
Jams 45° |
Montants à 45° |
Türstockverkleidung 45° |
Jambas en 45°

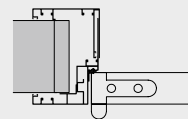
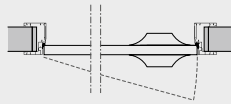

blow

pag 12



Stipiti a 45° |
Jams 45° |
Montants à 45° |
Türstockverkleidung 45° |
Jambas en 45°

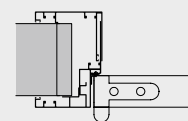
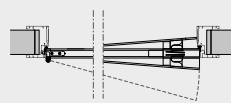

integra

pag 14



Integra in legno su muratura o cartongesso |
Integra in wood for application on wall or plasterboard |
Integra en bois pour application sur maçonnerie ou plâtre |
Integra in Holz fuer Mauerwerk oder Gipskartonplatten |
Integra en madera en mampostería o pladur

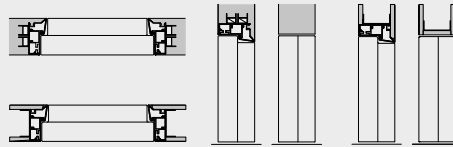

Coprifiti personalizzabili |
Customized finishing lists |
Montants personnalisés |
wahlweisen Verkleidungen |
Tapetas personalizables

Filomuro |
Flush door |
Ras de mur |
Drehtüren zum Ziehen |
Enrasada a la pared

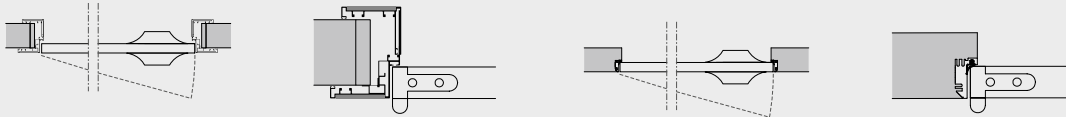

Coprifiti personalizzabili |
Customized finishing lists |
Montants personnalisés |
wahlweisen Verkleidungen |
Tapetas personalizables

Filomuro |
Flush door |
Ras de mur |
Drehtüren zum Ziehen |
Enrasada a la pared

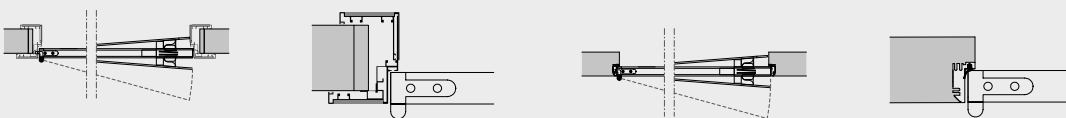

next

pag 18



Applicazione su muratura nella versione a tirare |
Application on wall with pull version |
Application sur maçonnerie dans la version à tirer |
Anwendung auf Mauerwerk in der Ziehenversion |
Aplicación de albanilería en la versión de tirar

Applicazione su cartongesso nella versione a spingere |
Application on plasterboard with push version |
Application sur placoplâtre dans la version à pousser |
Anwendung auf Gipskartonplatten in der Druckversion |
Aplicación de placas de yeso en la versión de empujar

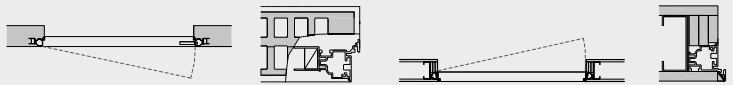

and

pag 20



Apertura SX a tirare |
Opening left to pull |
Ouverture gauche à tirer |
Öffnung nach Links zu ziehen |
Abertura izquierda para tirar

Apertura SX a spingere |
Opening left to push |
Ouverture gauche à pousser |
Öffnung nach Links zu drücken |
Abertura izquierda para empujar

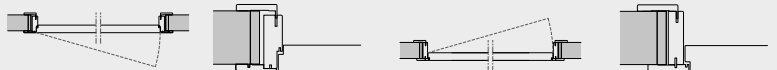

ri-trait
8b

pag 22 / pag 24



Stipiti a 45° | Jams 45° | Montants à 45° | Türstockverkleidung 45° | Jambas en 45°

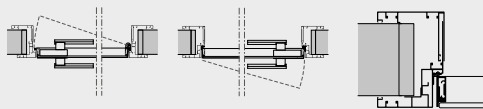

Ri-trait

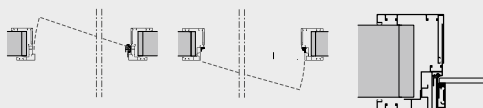

Ri-trait 8b

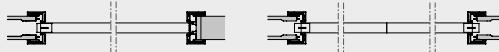

Ri-trait / Ri-trait 8b

Filomuro
Flush door
Ras de mur
Wandbündige
Enrasada a la pared

Filomuro a tutta altezza |
Flush door all height |
Ras de mur toute hauteur |
Wandbündige ganze Höhe |
Enrasada a la pared al techo

Filomuro doppia |
Flush door double |
Ras de mur double |
Wandbündige doppel |
Enrasada a la pared doble

Filomuro doppia a tutta altezza |
Double flush door all height |
Ras de mur double toute hauteur |
Wandbündige doppel ganze Höhe |
Enrasada a la pared doble al techo

Filomuro obliqua |
Oblique flush door |
Ras de mur oblique |
Wandbündige schrägdrehtür |
Enrasada a la pared oblicua

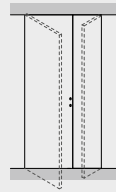
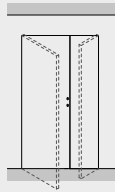

prima

pag 26



Stipiti a 45° | Jambas 45° | Montants à 45° | Türstockverkleidung 45° | Jambas en 45°

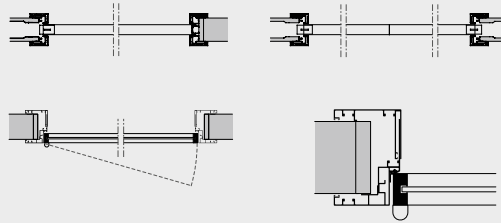

Senza stipiti | Without jambs | Sans jambages | Ohne Pfosten | Sin jambas

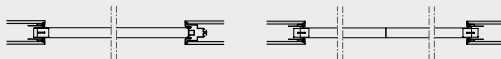

Coprifilati personalizzabili | Customized finishing lists | Montants personnalisés |
wahlweisen Verkleidungen | Tapetas personalizables

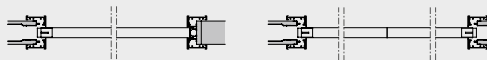
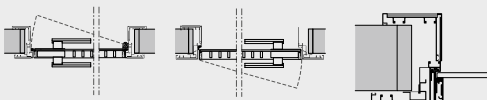
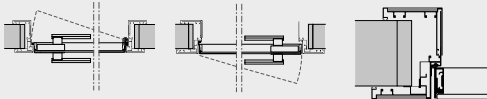

Filomuro | Flush door | Ras de mur | Drehtüren zum Ziehen | Enrasada a la pared

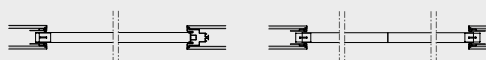
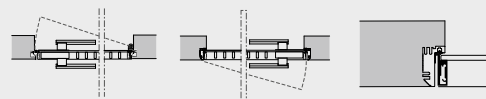
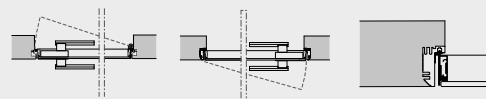

Ri-trait

Ri-trait 8b

Ri-trait /
Ri-trait 8b

quadra bilico

pag 28



Filomuro |
Flush door |
Ras de mur |
Drehtüren zum Ziehen |
Enrasada a la pared

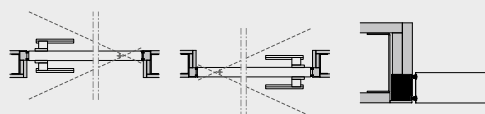

quadra battente scomparsa

pag 28



Stipiti a 45° | Jams 45° | Montants à 45° | Türstockverkleidung 45° | Jambas en 45°

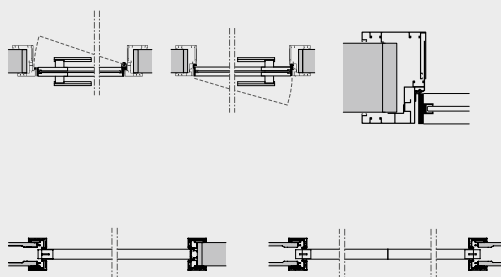

Corridoio |
Hallway |
Couloir |
Gangdrehtüren |
Corredor

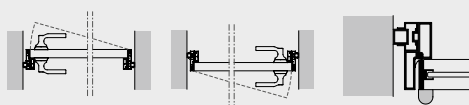

Corridoio |
Hallway |
Coulir |
Gangdrehüren |
Corredor

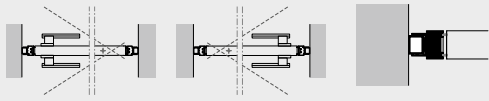

Coprifili personalizzabili | Customized finishing lists | Montants personnalisés
| Wahlweisen Verkleidungen | Tapetas personalizables

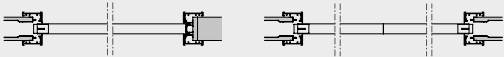
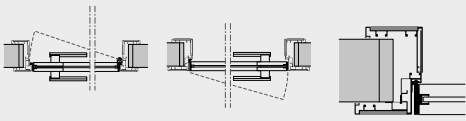

Filomuro | Flush door | Ras de mur | Drehüren zum Ziehen | Enrasada a la pared

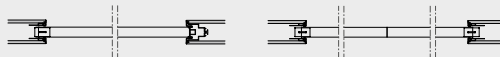
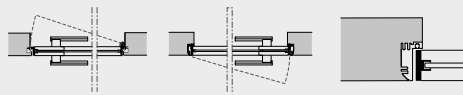

beat

pag 32



Aperture |
Openings |
Ouvertures |
Oeffnungen |
Aberturas

Stipiti a 45° | Jams 45° | Montants a 45° |
Türstockverkleidung 45° | Jambas en 45°

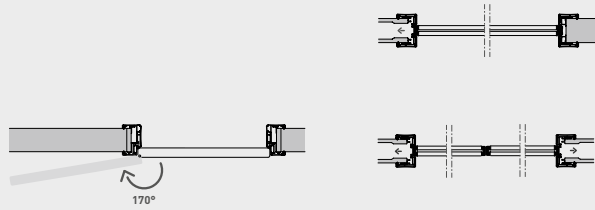

sail

pag 36



Stipiti a 45° |
Jams 45° |
Montants à 45° |
Türstockverkleidung 45° |
Jambas en 45°

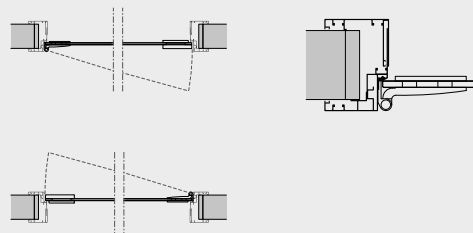

céline

pag 40



Stipiti a 45° | Jams 45° | Montants à 45° | Türstockverkleidung 45° | Jambas en 45°

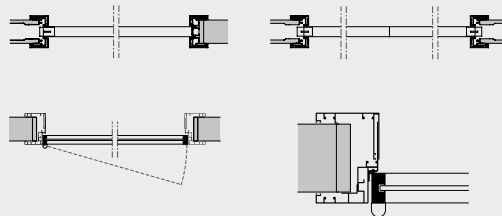

Senza stipiti | Without jams | Sans jambages | Ohne Pfosten | Sin jambas

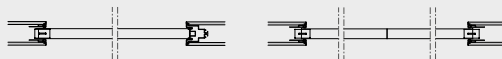

dot

pag 34



Tipologia di apertura per cristallo |
Type of opening for crystal |
Type ouverture pour cristal |
Typ der Öffnung für Kristall |
Tipo de abertura para cristal

Stipite telescopico |
Telescopic jamb |
Montant télescopique |
Teleskopischer Pfosten |
Jamba telescópica

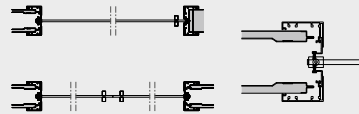
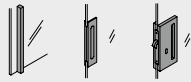

boisé

pag 38



Pianta | Plan | Plan | Plan | Planta

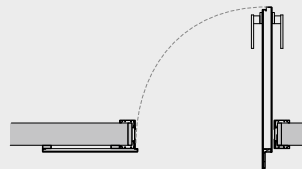
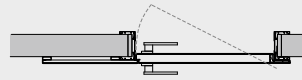

quies

pag 42



Stipiti a 45° |
Jambes 45° |
Montants à 45° |
Türstockverkleidung 45° |
Jambas en 45°

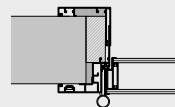
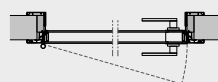

porte / scorrevoli

La costante ricerca nasce dalla consapevolezza che anche il semplice gesto di appoggiare la mano sulla maniglia e aprire una porta ha un valore enorme. La porta si apre e di fronte a noi si compie una parte del nostro vivere.

The continuous research comes from the awareness that even the simple act of putting the hand on the handle and opening the door has a huge meaning. The door opens and in front of us a part of our life comes alive. We have established a sort of border for what we think we can do.

La recherche constante naît de la conscience que même le geste simple consistant à poser la main sur la poignée et à ouvrir une porte revêt une valeur énorme. La porte s'ouvre et une partie de notre mode de vie se réalise devant nos yeux.

Wir glauben der Ansicht sind, dass auch die einfache Betätigung des Griffs zum Öffnen einer Tür eine große Bedeutung hat. Die Tür öffnet sich und begleitet uns bei der Ausführung bestimmter Tätigkeiten, die Teil unseres Lebens sind.

La búsqueda constante nace de la conciencia de saber que incluso el simple gesto de apoyar la mano en el tirador para abrir una puerta posee un valor enorme. La puerta se abre y ante nosotros se cumple una parte de nuestro vivir.

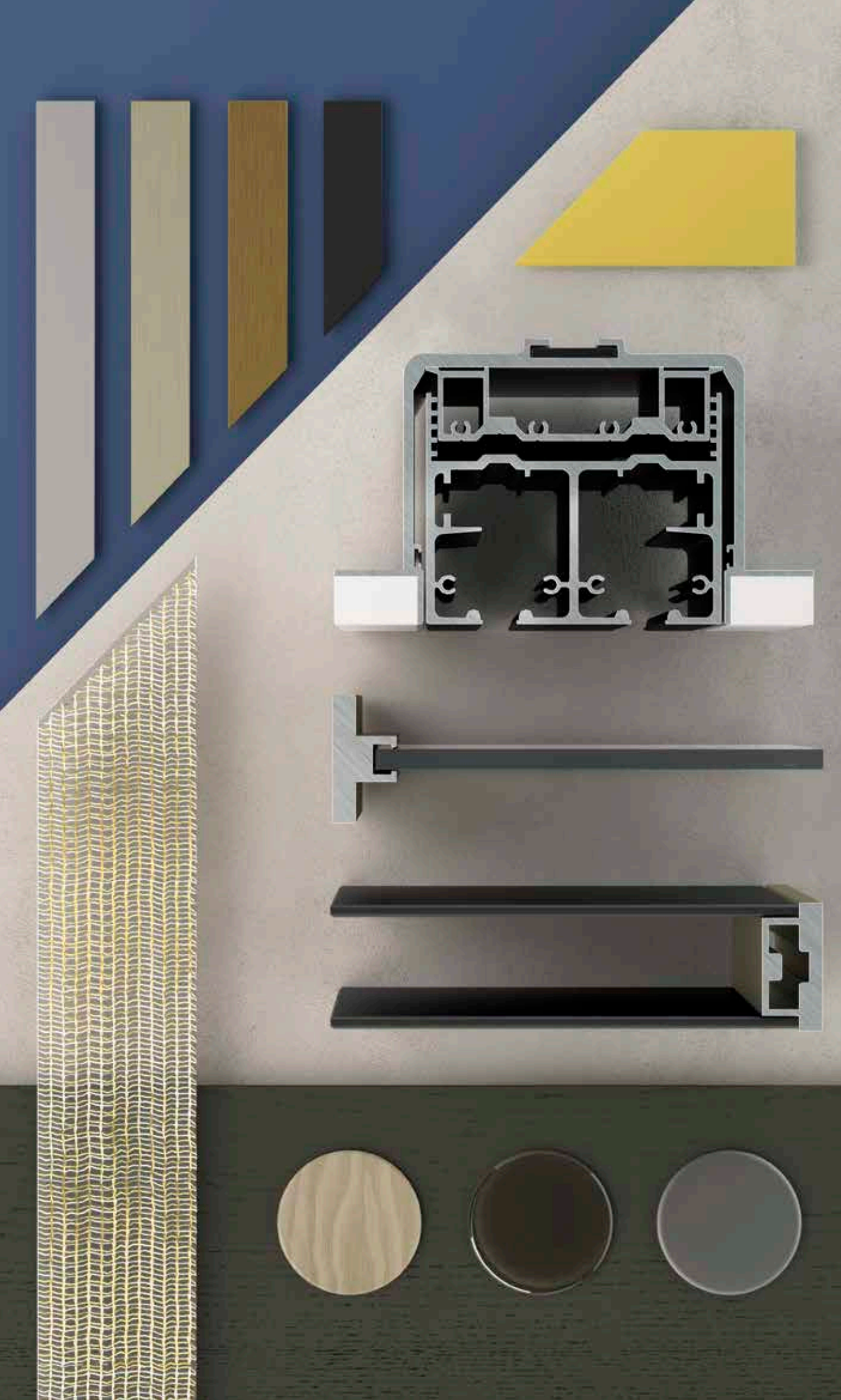

and

Designed by: CRS albed

Typology: Porta scorrevole | Sliding door | Porte coulissante | Schiebetür | Puerta corredera

And battente, pannello laccato. La porta che nella sua semplicità racchiude le peculiarità del savoir faire. Accurata artigianalità nella lavorazione del legno, nel pannello e nello stipite.

Swing door And with lacquered panel. The simplicity of this door contains all the peculiarities of savoir faire. Careful craftsmanship in woodworking, panel door and jamb.

And battante, panneau verniés. La porte And dans sa simplicité embrasse tous les particularités du savoir-faire. Soin artisanal pour le travail du bois, pour les panneaux et les montants.

And Drehtür, lackiertes Paneel. Die Tür, die in ihrer Einfachheit, die Besonderheit von "savoir faire" enthält. Genaue Handwerkskunst in der Verarbeitung des Holzes, im Paneel und im Pfosten. Die Technologie versichert die Wandbündigkeit der Tür und erlaubt eine Öffnung sowohl zum Ziehen als auch zum Drücken.

Puerta batiente And con panel lacado. La puerta que en su sencillez incluye las peculiaridades del savoir faire. Precisión en el trabajo de la madera, de los paneles y de los marcos.





①

②

porte scorevoli

54 / 55

and

① Binario invisibile | Invisible rail | Rail invisible | Unsichtbarer Schiene | Guía invisible

② Maniglia incassata | Recessed handle | Poignée encastrée | Griffmulde | Tirador Empotrado

ri-trait

Designed by: CRS albed

Typology: Porta scorrevole | Sliding door | Porte coulissante | Schiebetür | Puerta corredera

Il concept e l'identità del modello si racchiudono in una sola parola: leggerezza, ovvero la volontà di alleggerire le forme e i materiali e snellire l'insieme per un prodotto minimale. Così nasce Ri-Trait.

The concept and the identity of the model can be described in one word: lightness. In a few more: that's the desire to lighten the structure and materials used, in order to streamline the product and create a truly minimalist object. This is Ri-Trait.

Le concept et l'identité du modèle sont inclus dans un mot: légèreté, c'est à dire le désir d'alléger les formes et de rationaliser l'ensemble pour un produit minimal. Ainsi est né Ri-Trait.

Das Konzept und die Identität des Modells werden in einem einzigen Wort eingeschlossen: Leichtigkeit. Nämlich der Wunsch, die Formen und Materialien zu erleichtern und die Menge für eine minimale Produkt optimieren. So Ri-Trait geboren wurde.

El concepto y la identidad de la modelo están encerrados en una sola palabra: la ligereza. A saber, el deseo de aligerar las formas y materiales y racionalizar el conjunto de un producto mínimo. Así nació Ri-Trait.





porte scorrevoli

56 / 57

ri-trait

ri-trait 8b

Designed by: CRS albed

Typology: Porta scorrevole | Sliding door | Porte coulissante | Schiebetür | Puerta corredera



① Binario a 2 vie incassato a filo del soffitto | 2 way built-in ceiling rail | 2 voies au plafond encaissé | 2 Wege eingelassene Deckenschiene | 2 vías a ras del techo



prima

Designed by: CRS albed

Typology: Porta scorrevole | Sliding door | Porte coulissante | Schiebetür | Puerta corredera

La semplicità diventa protagonista della collezione, che si materializza nel sottile profilo delle strutture, per permettere con più agio il passaggio della luce, e per impreziosire gli ambienti che la ospitano.

The simplicity becomes the star of the collection, which is clearly shown by the slim profile of the structures, which allows the ease of passage of the light, and enriches all the ambiances around.

La simplicité devient le protagoniste de la collection, qui se matérialise dans le profil mince des structures, pour permettre de faciliter le passage de la lumière, et d'enrichir les environnements qui hébergent.

Die Einfachheit wird Hauptfigur der Kollektion, die im schlanken Profil der Strukturen verwirklicht wird, den Durchgang von Licht zu ermöglichen, und die Umgebungen zu bereichern.

La sencillez también es la estrella de la colección, que se materializa en el perfil delgado de las estructuras, para permitir una mayor facilidad el paso de la luz, y para enriquecer los ambientes que albergan.



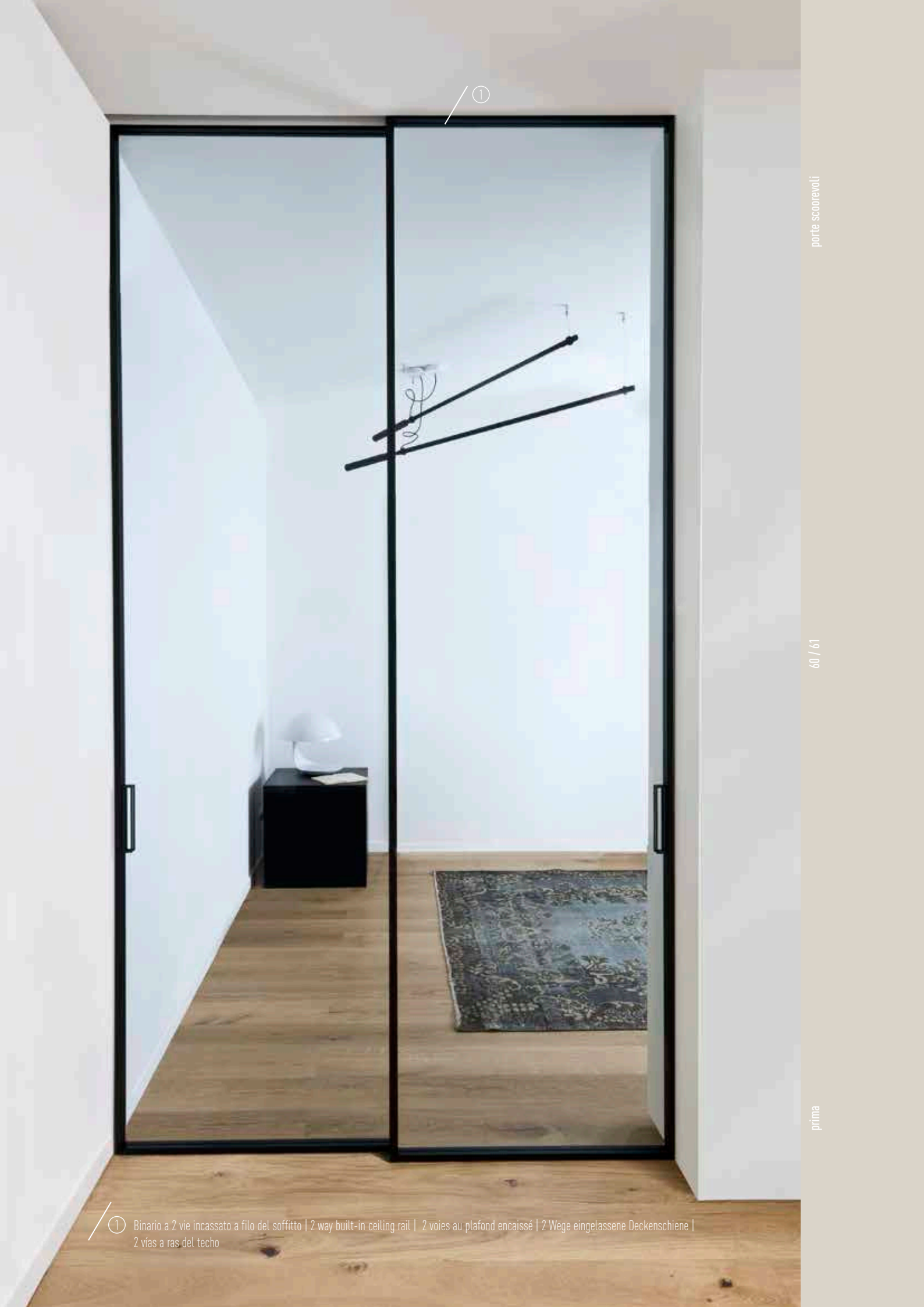

porte scorevoli

60 / 61

prima

① Binario a 2 vie incassato a filo del soffitto | 2 way built-in ceiling rail | 2 voies au plafond encaissé | 2 Wege eingelassene Deckenschiene | 2 vías a ras del techo

quadra

Designed by: CRS albed

Typology: Porta scorrevole | Sliding door | Porte coulissante | Schiebetür | Puerta corredera

Pulizia delle linee e geometria secca, per Quadra, una porta dove la tecnicità estetica dei profili diventa protagonista del segno progettuale.

Clean lines and geometric clarity define Quadra, a door with a technical profile that is perfect for dividing areas in which every furnishing element in the home is an important piece of decor.

Des lignes épurées et une géométrie brute pour Quadra, une porte aux profilés techniques qui répond parfaitement aux besoins en termes de séparation des pièces, lorsque chaque élément de la maison joue un rôle de protagoniste.

Saubere Linien und nüchterne Geometrie für Quadra, eine Tür mit technischen Profilen, um besser dem Anspruch auf Unterteilung solcher Räume zu entsprechen, in denen jedes Element der Wohnung eine vordergründige Rolle spielt.

Líneas limpias y geometría seca definen Quadra, una puerta con perfiles técnicos para adaptarse en la mejor manera a las exigencias de subdivisión de los ambientes, en los cuales cada elemento de la casa juega un papel de protagonista.

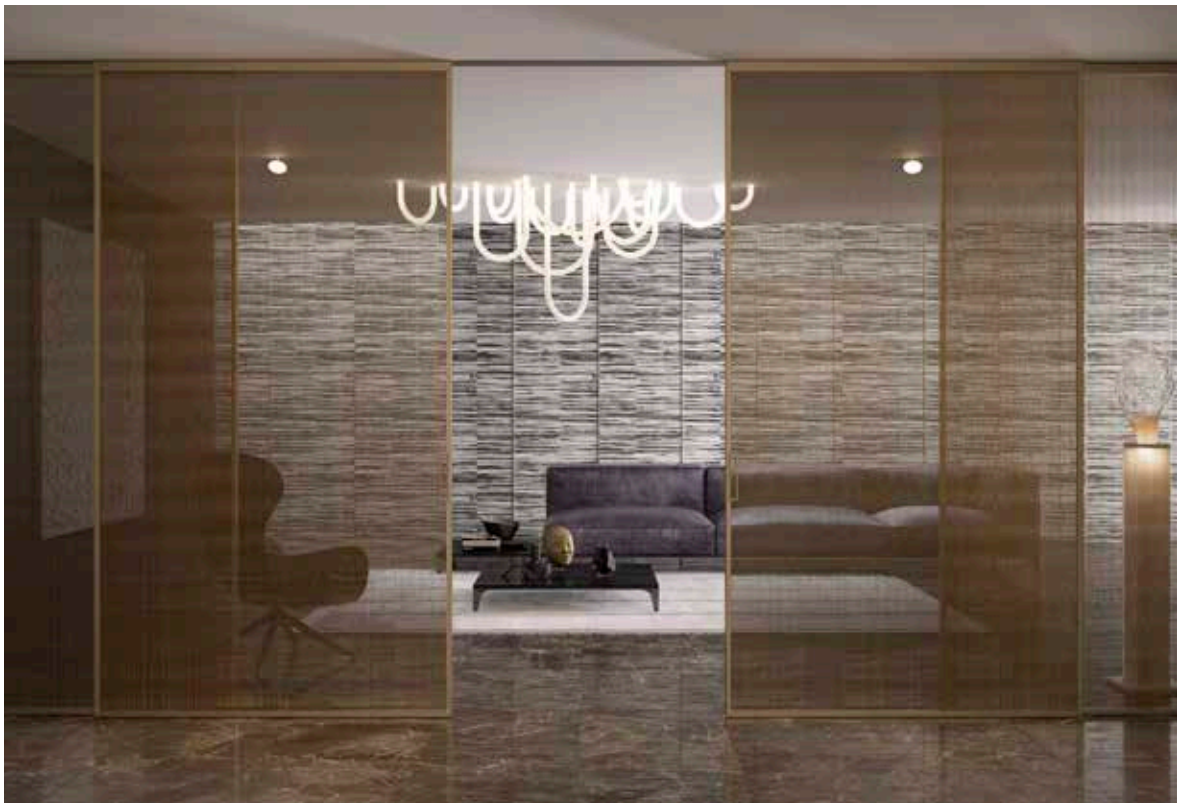



① Vetro con tessuto Delux Gold | Fabric Delux Gold glass | Verre Delux Gold | Stoff Delux Gold | Vidrio con tejido Delux Gold

② Profili e maniglia in alluminio anodizzato champagne | Profiles and handle in champagne anodized aluminium | Profils et poignée en aluminium anodisé champagne | Rahmen und Griff in Aluminium Champagne anodisiert | Perfil y maneta en aluminio anodizado champagne



① Profili in finitura nero e vetri neutro extrachiario | Black profiles and transparent glasses | Profils en finition noir et verre transparent |
Rahmen in schwarz und Klarglas | Perfiles en negro y vidrio transparente



② /
Versione scorrevole 4 ante con binario a due vie | Sliding version with 4 panels with 2 ways rail | Version coulissante 4 panneaux avec rail à deux voies |
Version mit 4 Schiebetüren mit 2 Führungsbahnen | Versión corredera con 4 puertas con guía a 2 vías

beat

Designed by: CRS albed

Typology: Porta scorrevole | Sliding door | Porte coulissante | Schiebetür | Puerta corredera

Estetica. Tecnologia. Valore d'arredo. Queste sono le premesse della porta Beat e realizzano un obiettivo preciso: coniugare architettura e interior design, restituendo alla porta tutta la sua valenza di oggetto fondamentale nella gestione degli spazi.

Aesthetics. Technology. Value of furnishing. These are the basis for the Beat door and they achieve a precise objective: to match architecture and interior design, giving back to the door all of its value as a fundamental object in the management of spaces.

Esthétique. Technologie. Ameublement de qualité. Ces sont les intentions pour la porte Beat, qui réalise un objectif précis: conjuguer architecture et "intérieur design", en donnant à la porte tout son rôle d'objet fondamental dans la gestion de l'espace.

Ästhetik. Technologie. Wert der Einrichtung. Beat strebt ein präzises Ziel an: Architektur und Interior Design zu verbinden und dennoch die Bedeutung der Türe für die Organisation des Raums zu unterstreichen.

Estética. Tecnología. Valor del adorno. Estas son las premisas de la puerta Beat y realizan un objetivo preciso: conjugar arquitectura e interior design, devolviendo a la puerta su importancia de objeto fundamental en la gestión de los espacios.





porte scorevoli

66 / 67

beat

① Telaio in frassino light brown | Frame in frassino light brown | Cadre en aluminium plaque frassino light brown |
Türrahmen aus Aluminium mit frassino light brown | Marco en frassino light brown

quinta

Designed by: Paolo Festa

Typology: Porta scorrevole | Sliding door | Porte coulissante | Schiebetür | Puerta corredera

Alluminio e vetro uniti a creare un divisorio teatrale, da cui il nome Quinta. Una soluzione scorrevole per dividere gli ambienti, separare gli spazi o come chiusura per nicchie e cabine armadio.

Aluminium and glass united to create a theatrical partition, given the name of Quinta. It's a sliding solution to divide living areas, separate spaces, or to close off niches and walk-in closets.

Aluminium et verre combinées pour créer un théâtre de partition, d'où le nom Quinta. Une solution coulissante pour chambres, des espaces à séparer ou pour des niches et placards.

Aluminium und Glas kombiniert, um eine Theaterpartition, von dem der Name Quinta zu erstellen. Ein gleitender Lösung zur Unterteilung des Livingzimmers, separate Räume oder als Verschluss für Nischen und begehbare Kleiderschränke.

Aluminio y vidrio combinados para crear una partición teatral, de la cual el nombre de Quinta. Una solución móvil como tabique de habitación living, espacios separados o como cierre de nichos y vestidores.





① Binario a parete | Wall rail | Rail au mur | Wandschiene | Riel de pared

② Maniglia in legno di rovere massello | Handle in solid oak wood | Poignée en chêne massif | Griff aus massivem Eichenholz | Tirador de roble macizo

①



① Binario a 2 vie incassato a filo del soffitto | 2 way built-in ceiling rail | 2 voies au plafond encaissé | 2 Wege eingelassene Deckenschiene |
2 vías a ras del techo



②

Profili in alluminio anodizzato champagne | Profiles in champagne anodized aluminium | Profils en aluminium anodisé champagne |
Rahmen in Aluminium Champagne anodisiert | Perfil en aluminio anodizado champagne

dot

Designed by: CRS albed

Typology: Porta scorrevole | Sliding door | Porte coulissante | Schiebetür | Puerta corredera

La linearità nella sua forma più pura, quasi eterea, dove la forza della struttura è nascosta da un'immagine di totale leggerezza. Dot da movimento alla luce.

Linearity with the purest, almost ethereal, shape, where a sturdy structure is concealed with extreme lightness. Dot adds variety to light.

Avec sa forme linéaire très pure, presque éthérée, où la force de la structure se cache dans une apparence de légèreté totale, Dot donne mouvement à la lumière.

Einfachheit in ihrer reinsten Form, fast ätherisch, die Leichtigkeit des optischen Eindrucks lässt die Kraft der Struktur vergessen. Dot bewegt Licht.

La linealidad en su forma más pura, casi etérea, donde la fuerza de la estructura está escondida por una imagen de total ligereza. Dot da movimiento a la luz.

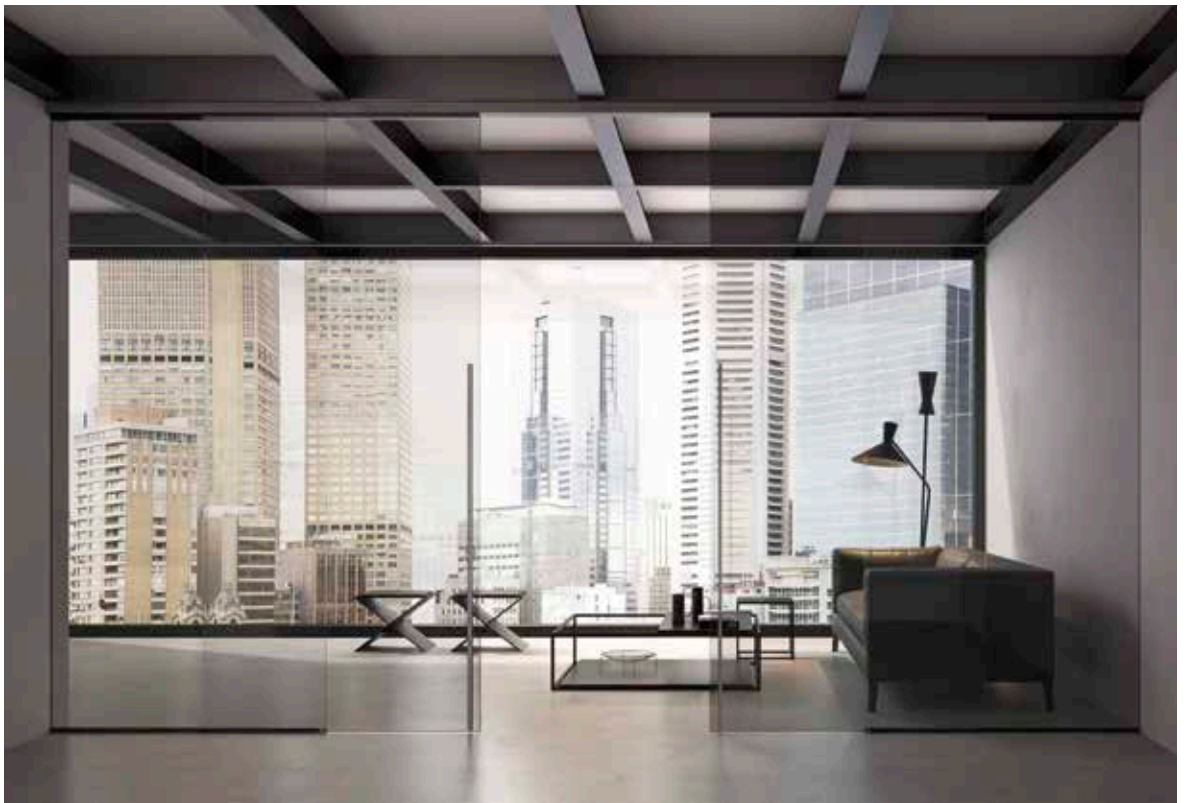



porte scorrevoli

72 / 73

dot

① Maniglia "H" in alluminio | Handle "H" in aluminum | Poignée "H" en aluminium | Griff "H" aus Aluminium | Tirador "H" en aluminio

sail

Designed by: Paolo Bistacchi

Typology: Porta scorrevole | Sliding door | Porte coulissante | Schiebetür | Puerta corredera

I movimenti silenziosi, sicuri, gesti che diventano quotidiani e che raccontano l'uso dello spazio. La porta scorrevole Sail dà un impulso all'architettura nel segno di una perfetta integrazione stilistica e funzionale.

Silent movements, safe secure motions that become familiar and reveal the use of the space. The Sail sliding door adds a nice touch to the architecture, with its perfect stylistic and functional integration.

Des mouvements silencieux, fiables, des gestes quotidiens qui racontent l'utilisation de l'espace. La porte coulissante Sail donne une nouvelle impulsion à l'architecture avec l'intégration parfaite du style et de l'aspect fonctionnel.

Geräuscharmes und zuverlässiges Verschieben, bei täglicher Benutzung, das macht jeden Raum nutzbar. Die Schiebetür Sail gibt der Architektur Impulse und ist eine perfekte, stilistische und zweckmäßige Ergänzung.

Los movimientos silenciosos y seguros, gestos cotidianos que cuentan el uso del espacio. La puerta corredera Sail da un impulso a la arquitectura en el signo de una perfecta integración estilística y funcional.





① Binario a parete | Wall rail | Rail au mur | Wandschiene | Riel de pared

② Vetro acidato con grafica stampata: Tweed Grigio | Frosted glass with printed graphic: Tweed Grigio | Verre acidé avec graphisme imprimé: Tweed Grigio | Glas satiniert mit gedrückter Grafik: Tweed Grigio | Vidrio al acido con grafica impresa: Tweed Grigio

céline

Designed by: Paolo Festa

Typology: Porta scorrevole | Sliding door | Porte coulissante | Schiebetür | Puerta corredera

Leggerezza, trasparenza, capacità di dividere e unire allo stesso tempo. Un progetto che prende spunto dalla partitura tipica degli ambienti giapponesi e allo stesso tempo si regola ispirandosi alle vetrate industriali dei primi del '900. Céline riporta la tradizione in un contesto contemporaneo.

Lightness, transparency, ability to divide and connect at the same time, that's all it is. A project that combines partitions typical of Japanese taste with industrial wall of glass from the early XX century. Céline brings tradition back into a contemporary contest.

Légèreté, transparence, capacité à diviser et à unir à la fois. Un projet qui s'inspire aux partitionnes typiques des environnements japonais et au même temps du vitrage industriel du début du XXème siècle. Céline ramène la tradition dans un contexte contemporain.

Leichtigkeit und Durchsichtigkeit, Trennungs- und Vereinigungsfähigkeit zur gleichen Zeit. Ein Projekt, dass sich an der typischen japanischen Szenerie orientiert und gleichzeitig von der industriellen Glasur des frühen 20. Jahrhunderts inspiriert wird. Céline bringt Tradition in einen zeitgenössischen Kontext zurück.

Ligereza, transparencia, capacidad de dividir y unir al mismo tiempo. Un proyecto que toma su ejemplo del ambiente típico japonés y al mismo tiempo está inspirado en el acristalamiento industrial de principio del siglo XX. Céline devuelve la tradición a un contexto contemporáneo.





porte scorrevoli

76 / 77

céline

① Profili e maniglia in anodizzato bronzo | Profiles and handle in bronze anodized aluminium | Profils et poignée en aluminium anodisé bronze |
Rahmen und Griff in Aluminium Bronze anodisiert | Perfil y maneta en aluminio anodizado bronce

and

pag 54



And scorrevole con binario invisibile | Sliding door And with invisible rail | And coulissante avec rail invisible | And Schiebetür mit unsichtbarer Schiene | Puerta corredera And con guía invisible

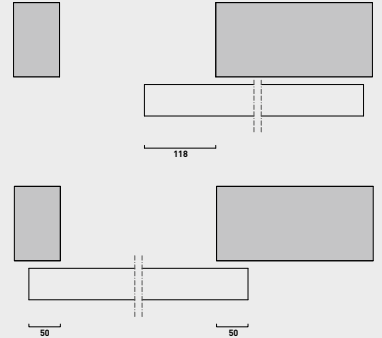
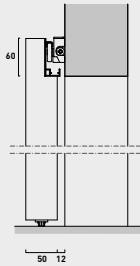

ri-trait
8b

pag 56 / pag 58



Il carrello consente la regolazione verticale del pannello scorrevole | The truck allows vertical adjustments of the sliding panel | Le chariot permet le réglage vertical du panneau coulissant | Der Wagen ermöglicht eine vertikale Einstellung der Schiebetür | El carrito permite el ajuste vertical del panel corredero



Ri-trait

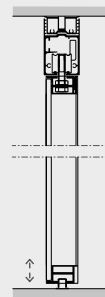

Ri-trait 8b

prima

pag 60



Il carrello consente la regolazione verticale del pannello scorrevole | The truck allows vertical adjustments of the sliding panel | Le chariot permet le réglage vertical du panneau coulissant | Der Wagen ermöglicht eine vertikale Einstellung der Schiebetür | El carrito permite el ajuste vertical del panel corredero

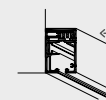
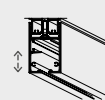
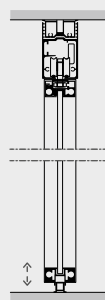

sail
scorrevole

pag 74



Porta totalmente in vetro, singola o doppia con possibilità di regolazione del binario, chiusura e apertura ammortizzata, possibilità di specchiature trasparenti o satinate | Door entirely in glass, single or double with adjustable track, soft opening and closing system, and possibility of transparent or satin mirrors | Porte entièrement en verre, simple ou double avec voie réglable, ouverture et fermeture douce, et possibilité de miroirs transparente ou satinée | Vollständige Tür in Glas, einfach oder doppelt mit einstellbarer Schiene, weiches Öffnen und Schließen, und Möglichkeit der Transparenten oder Satin Spiegel | Puerta completamente en vidrio, simple o doble con binario ajustable, apertura y cierre suave, y posibilidad de espejos transparentes o satinados

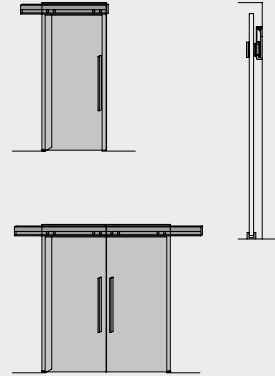

Applicazione su cartongesso con binario a 1, 2 vie incassato a filo del soffitto | Application on plasterboard with 1, 2 way built-in ceiling rail | Application sur placoplâtre avec rail 1, 2 voies au plafond encaissé | Anwendung auf Gipskartonplatten mit 1,2 Wege eingelassene Deckenschiene | Aplicación al pladur con el binario de 1, 2 vías a ras del techo

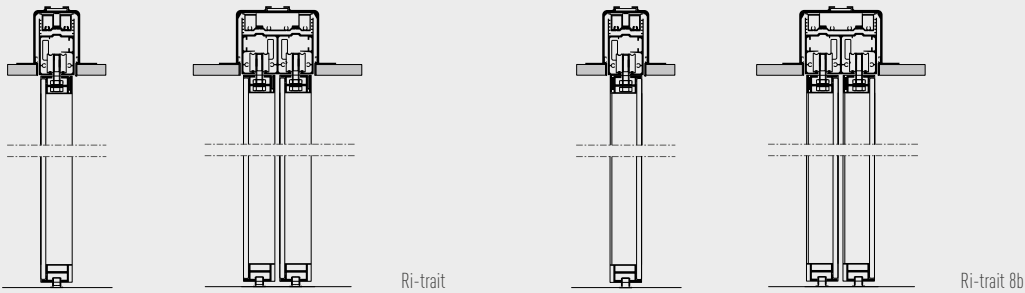

Applicazione su cartongesso con binario a 1, 2 vie incassato a filo del soffitto | Application on plasterboard with 1, 2 way built-in ceiling rail | Application sur placoplâtre avec rail 1, 2 voies au plafond encaissé | Anwendung auf Gipskartonplatten mit 1,2 Wege eingelassene Deckenschiene | Aplicación al pladur con el binario de 1, 2 vías a ras del techo

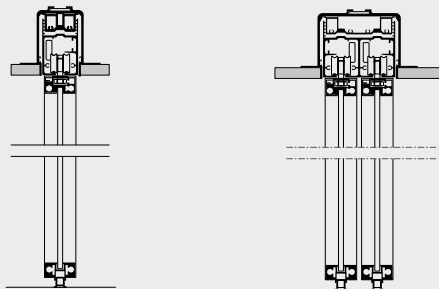

quadra

pag 62



Il carrello consente la regolazione verticale del pannello scorrevole | The truck allows vertical adjustments of the sliding panel | Le chariot permet le réglage vertical du panneau coulissant | Der Wagen ermöglicht eine vertikale Einstellung der Schiebetür | El carrito permite el ajuste vertical del panel corredero

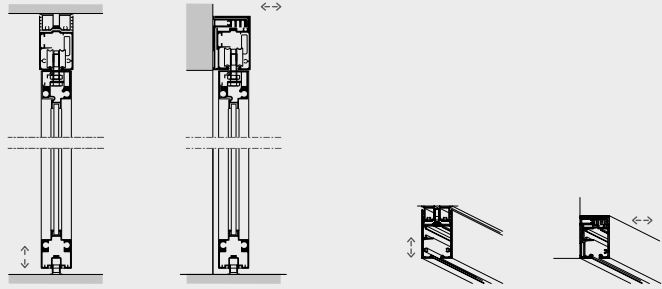

beat

pag 66



Il carrello consente la regolazione verticale del pannello scorrevole | The truck allows vertical adjustments of the sliding panel | Le chariot permet le réglage vertical du panneau coulissant | Der Wagen ermöglicht eine vertikale Einstellung der Schiebetür | El carrito permite el ajuste vertical del panel corredero

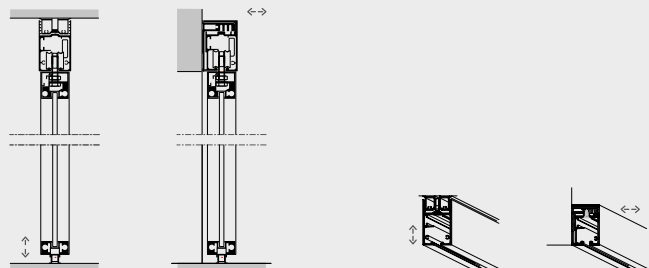

quinta

pag 68



Il carrello consente la regolazione verticale del pannello scorrevole | The truck allows vertical adjustments of the sliding panel | Le chariot permet le réglage vertical du panneau coulissant | Der Wagen ermöglicht eine vertikale Einstellung der Schiebetür | El carrito permite el ajuste vertical del panel corredero

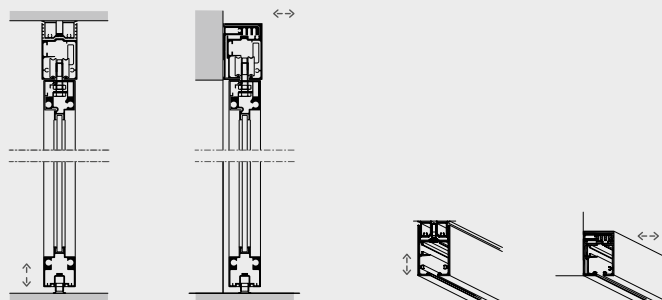

Applicazione su cartongesso con binario a 1,2 vie incassato a filo del soffitto | Application of plasterboard with 1,2-way built-in ceiling rail | Application sur placoplâtre avec rail 1,2 voies au plafond encaissé | Anwendung auf Gipskartonplatten mit 1,2-Wege eingelassene Deckenschiene | Aplicación al pladur con el binario de 1,2 vías a ras del techo

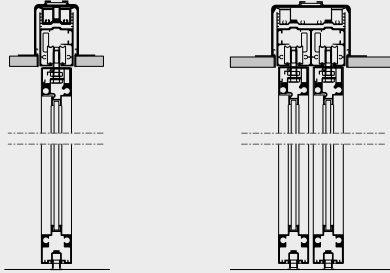

Applicazione su cartongesso con binario a 1,2 vie incassato a filo del soffitto | Application of plasterboard with 1,2-way built-in ceiling rail | Application sur placoplâtre avec rail 1,2 voies au plafond encaissé | Anwendung auf Gipskartonplatten mit 1,2-Wege eingelassene Deckenschiene | Aplicación al pladur con el binario de 1,2 vías a ras del techo

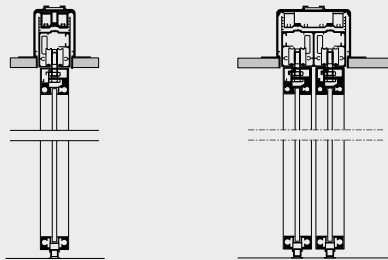

Applicazione su cartongesso con binario a 1,2 vie incassato a filo del soffitto | Application of plasterboard with 1,2-way built-in ceiling rail | Application sur placoplâtre avec rail 1,2 voies au plafond encaissé | Anwendung auf Gipskartonplatten mit 1,2-Wege eingelassene Deckenschiene | Aplicación al pladur con el binario de 1,2 vías a ras del techo

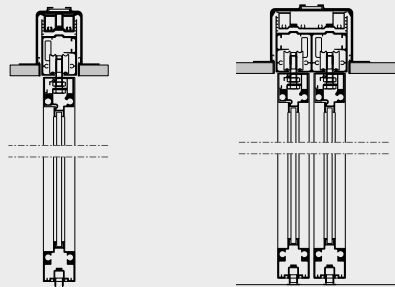

dot

pag 72



Il carrello consente la regolazione verticale del pannello scorrevole | The truck allows vertical adjustments of the sliding panel | Le chariot permet le réglage vertical du panneau coulissant | Der Wagen ermöglicht eine vertikale Einstellung der Schiebetür | El carrito permite el ajuste vertical del panel corredero

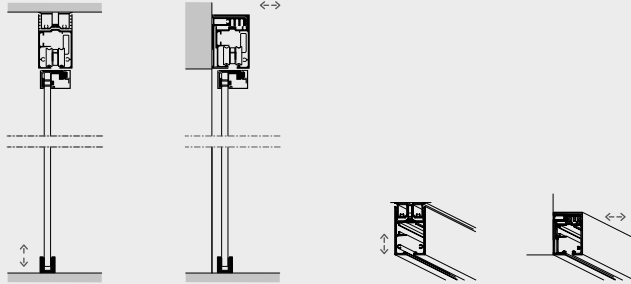

céline

pag 76



Il carrello consente la regolazione verticale del pannello scorrevole | The truck allows vertical adjustments of the sliding panel | Le chariot permet le réglage vertical du panneau coulissant | Der Wagen ermöglicht eine vertikale Einstellung der Schiebetür | El carrito permite el ajuste vertical del panel corredero

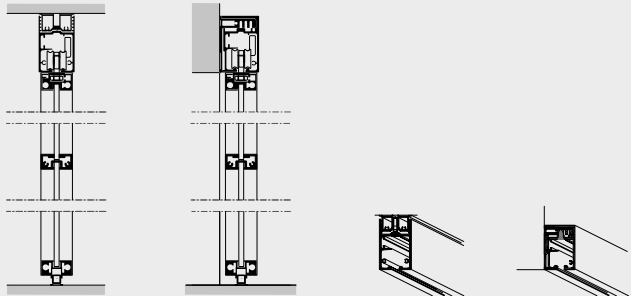

Applicazione su cartongesso con binario a 1,2 vie incassato a filo del soffitto | Application of plasterboard with 1,2-way built-in ceiling rail | Application sur placoplâtre avec rail 1,2 voies au plafond encaissé | Anwendung auf Gipskartonplatten mit 1,2-Wege eingelassene Deckenschiene | Aplicación al pladur con el binario de 1,2 vías a ras del techo

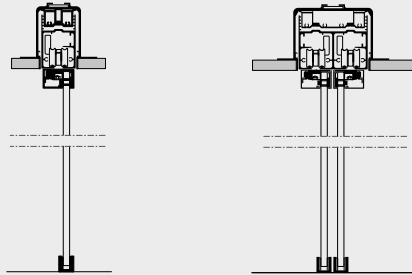

Applicazione su cartongesso con binario a 1,2 vie incassato a filo del soffitto | Application of plasterboard with 1,2-way built-in ceiling rail | Application sur placoplâtre avec rail 1,2 voies au plafond encaissé | Anwendung auf Gipskartonplatten mit 1,2-Wege eingelassene Deckenschiene | Aplicación al pladur con el binario de 1,2 vías a ras del techo

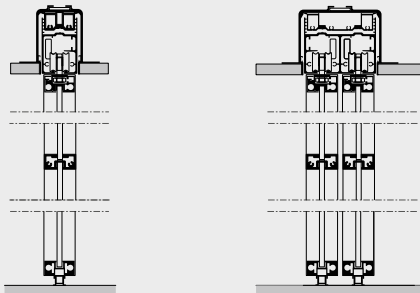

pareti divisorie

Ogni progetto è una storia a sé, le case non sono mai uguali, i muri le stanze, la luce, l'ombra, tutto cambia, ciò che non cambia invece sono i luoghi del nostro abitare, l'uomo nel suo abitare si riposa mangia, vive la socialità della sua famiglia e compie quotidianamente i suoi percorsi interni attraversando pareti che dividono o semplicemente segnano i confini del suo vivere.

Every project is unique, houses are never alike: walls, rooms, light, shadow, everything changes. But our living spaces do not change. In his home, a man relaxes, eats, experiences family relationships and passes everyday through walls that divide or just mark the borders of his living space.

Chaque projet est une histoire en soi : les maisons ne sont jamais les mêmes, les murs, les pièces, la lumière, l'ombre, tout change. En revanche, ce qui ne change pas, ce sont les lieux de notre habitation : dans son habitation, l'homme se repose, mange, vit sa vie de famille et effectue quotidiennement ses parcours internes à travers les murs qui divisent ou délimitent simplement son mode de vie.

Jedes Projekt hat seine eigene Geschichte, denn keine Wohnung gleicht der anderen: Mauern, Räume, Licht und Schatten sind immer unterschiedlich. Was gleich bleibt, sind die Funktionen eines Zuhauses, in dem man ausruht, isst, gemeinsame Momente mit der Familie verlebt und sich täglich bewegt.

Cada proyecto es una historia en sí misma, las casas nunca son iguales: las paredes, las habitaciones, la luz, la sombra, todo cambia, pero lo que no cambia son los lugares de nuestro habitar. El hombre en su hogar descansa, come, vive junto a su familia y realiza cotidianamente recorridos en su interior atravesando paredes que dividen o, sencillamente, marcan los límites de su vivir.



all ways

Designed by: CRS albed

Typology: Parete divisoria | Partition wall |
Paroi de separation | Trennwand | Pared divisoria

Il sistema All Ways è l'ideale per dividere e organizzare gli ambienti di lavoro.

The system All Ways is suitable for separating and organizing the workplace.

Le système All Ways est idéal pour la séparation et l'organisation du travail.

Das System All Ways ist ideal zum Trennen und Organisation des Arbeitsplatzes.

El sistema All Ways es ideal para separar y organizar el lugar de trabajo.





① Porta scorrevole | Sliding door | Porte coulissante | Schiebetür | Puerta corredera

② Profili e maniglia in anodizzato bronzo | Profiles and handle in bronze anodized aluminium | Profils et poignée en aluminium anodisé bronze | Rahmen und Griff in Aluminium Bronze anodisiert | Perfil y maneta en aluminio anodizado bronce

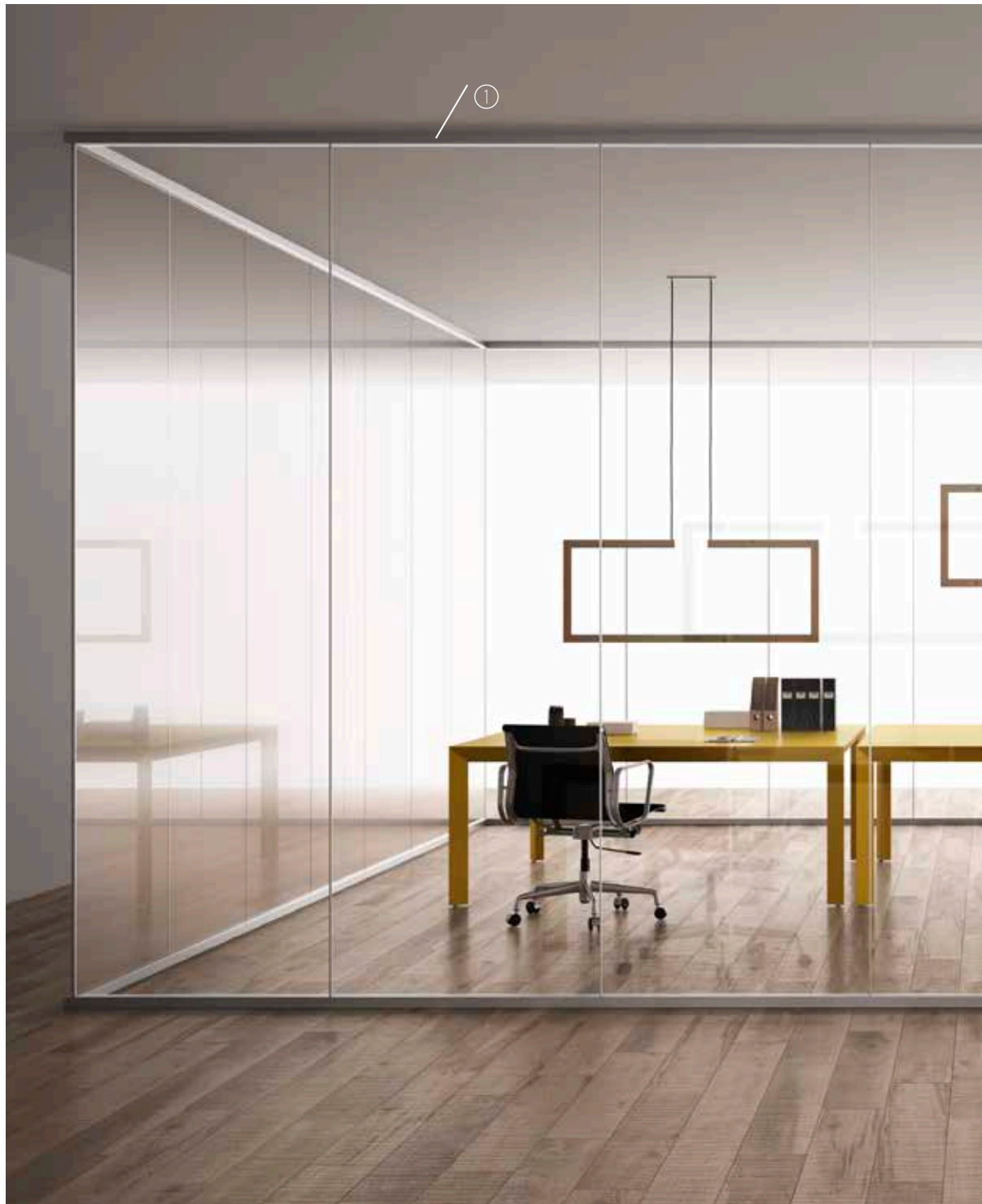

- ① Finitura profili alluminio, vetro neutro e vetro acidato ai lati | Aluminium profiles, transparent glass in the front and frosted glass on the sides |
Finition profils aluminium, verre neutro et acidé sur les côtés | Ausführung Rahmen Aluminium, Klarglas und Glas satiniert auf den Seiten |
acabado perfiles aluminio, vidrio transparente en frente y vidrio al ácido en los lados



céline

Designed by: Paolo Festa

Typology: Parete divisoria | Partition wall |

Paroi de separation | Trennwand | Pared divisoria

Leggerezza, trasparenza, capacità di dividere e unire allo stesso tempo. Un progetto che prende spunto dalla partitura tipica degli ambienti giapponesi e allo stesso tempo si regola ispirandosi alle vetrate industriali dei primi del '900. Céline riporta la tradizione in un contesto contemporaneo.

Lightness, transparency, ability to divide and connect at the same time, that's all it is. A project that combines partitions typical of Japanese taste with industrial wall of glass from the early XX century. Céline brings tradition back into a contemporary contest.

Légèreté, transparence, capacité à diviser et à unir à la fois. Un projet qui s'inspire aux partitionnes typiques des environnements japonais et au même temps du vitrage industriel du début du XXème siècle. Céline ramène la tradition dans un contexte contemporain.

Leichtigkeit und Durchsichtigkeit, Trennungs- und Vereinigungsfähigkeit zur gleichen Zeit. Ein Projekt, dass sich an der typischen japanischen Szenerie orientiert und gleichzeitig von der industriellen Glasur des frühen 20. Jahrhunderts inspiriert wird. Céline bringt Tradition in einen zeitgenössischen Kontext zurück.

Ligereza, transparencia, capacidad de dividir y unir al mismo tiempo. Un proyecto que toma su ejemplo del ambiente típico japonés y al mismo tiempo está inspirado en el acristalamiento industrial de principio del siglo XX. Céline devuelve la tradición a un contexto contemporáneo.

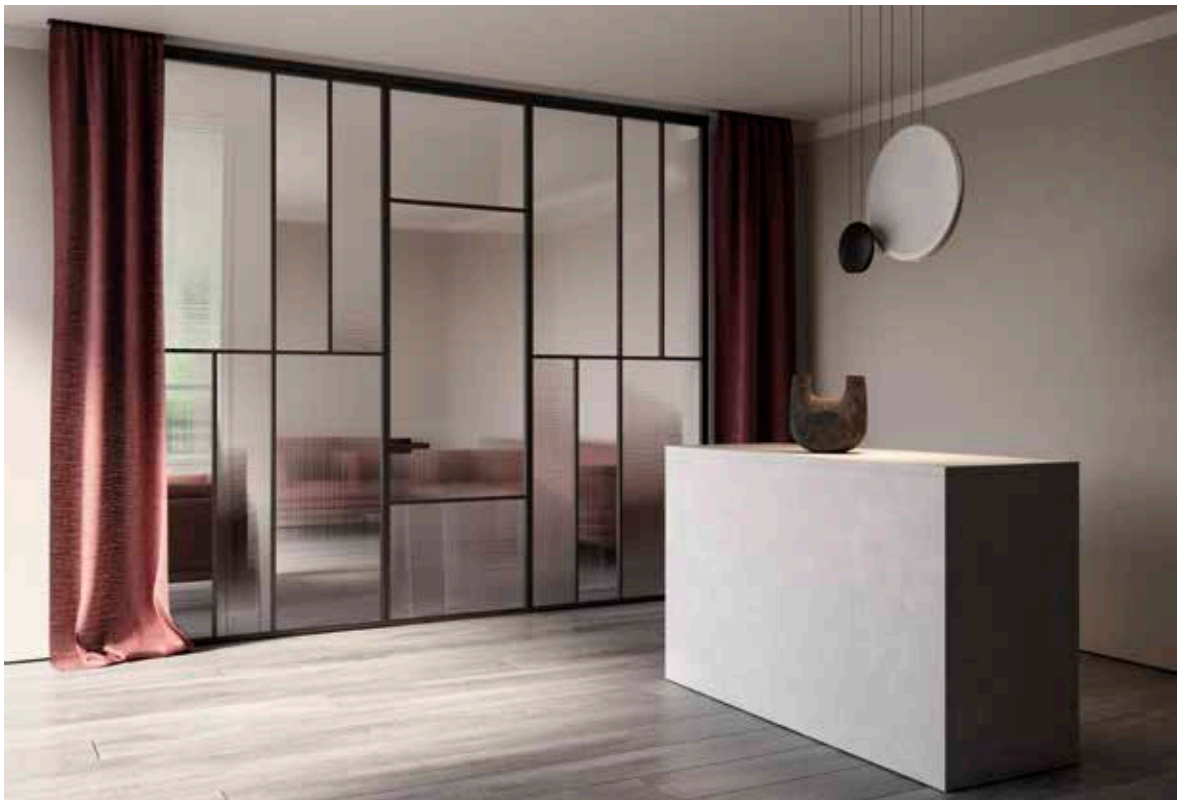



①

Profili in finitura nero e vetri Shanghai | Black profiles and Shanghai glasses | Profils en finition noir et verre Shanghai |
Rahmen in Schwarz und Glas Shanghai | perfiles en negro y vidrio Shanghai

all ways

pag 86



Porta battente |
Swing door |
Porte battante |
Drehtüren |
Puerta batiente

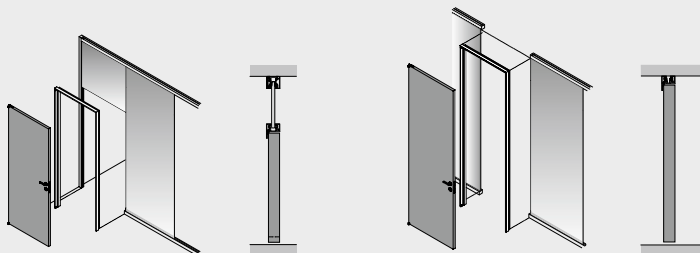

céline

pag 90



Parete divisoria | Partition wall | Paroi de separation | Trennwand | Pared divisoria



Porta scorrevole |
Sliding door |
Porte coulissante |
Schiebetür |
Puerta corredera

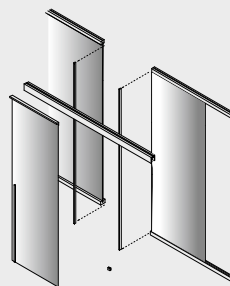
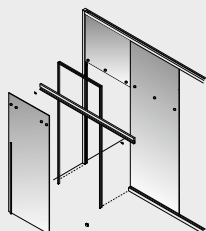
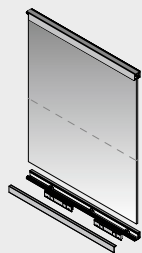

cabine

armadio

Ci siamo posti una sorta di confine segnato da ciò che oramai pensiamo di saper fare ed abbiamo iniziato a pensare negli anni alcuni semplici elementi che come una porta vivessero a contatto con le pareti cercando di definire il nostro concetto di abitare.

We have established a sort of border for what we think we can do. Over the years, we have started designing some simple elements that come in contact with the walls and try to define our concept of living.

Nous nous sommes imposé une sorte de limite marquée par ce que nous pensons désormais savoir faire, nous avons commencé à concevoir, au fil des ans, certains éléments simples qui, comme une porte, vivraient au contact des murs, en essayant de définir notre concept d'habitation.

Wir haben uns selbst eine Grenze gesetzt und konzentrieren uns auf das, was wir am besten können. Im Laufe der Jahre haben wir daher einige einfache Elemente entwickelt, die wie die Tür durch den Kontakt mit Wänden charakterisiert sind und über sie unser Wohnkonzept definiert.

Nos hemos fijado una especie de límite marcado por lo que creemos saber hacer, empezando a pensar en estos años en algunos sencillos elementos que, al igual que una puerta, pueden entrar en contacto con las paredes, e intentando definir nuestro concepto del habitar.



ri-vista

Designed by: CRS albed

Typology: Cabina armadio | Walk-in wardrobe |
Armoire-penderie | Schrank | Vestidor

Pur presentandosi con un'estetica apparentemente tradizionale, la cura dei dettagli e le soluzioni tecniche innovative rendono questa cabina armadio unica nella sua semplicità che diventa espressione di un gusto elegante e raffinato.

While presenting itself with an apparently traditional aesthetic, the attention to details and innovative technical solutions make this wardrobe system unique in its simplicity that becomes an expression of an elegant and refined taste.

Bien qu'elle se présente avec une esthétique apparemment traditionnelle, le soin des détails et les solutions techniques innovantes rendent cette armoire-penderie unique dans sa simplicité qui devient l'expression d'un goût élégant et raffiné.

Trotz einer auf den ersten Blick traditionell erscheinenden Ästhetik erweist sich dieser begehbare Kleiderschrank dank der sorgfältigen Details und innovativen technischen Lösungen als absolut einzigartig in seiner Schlichtheit, die sich in einem eleganten und edlen Stil ausdrückt.

A pesar de que se presenta con una estética aparentemente tradicional, el cuidado por los detalles y las soluciones técnicas innovadoras hacen que este vestidor sea único por su sencillez, convirtiéndose en expresión de un gusto elegante y refinado.

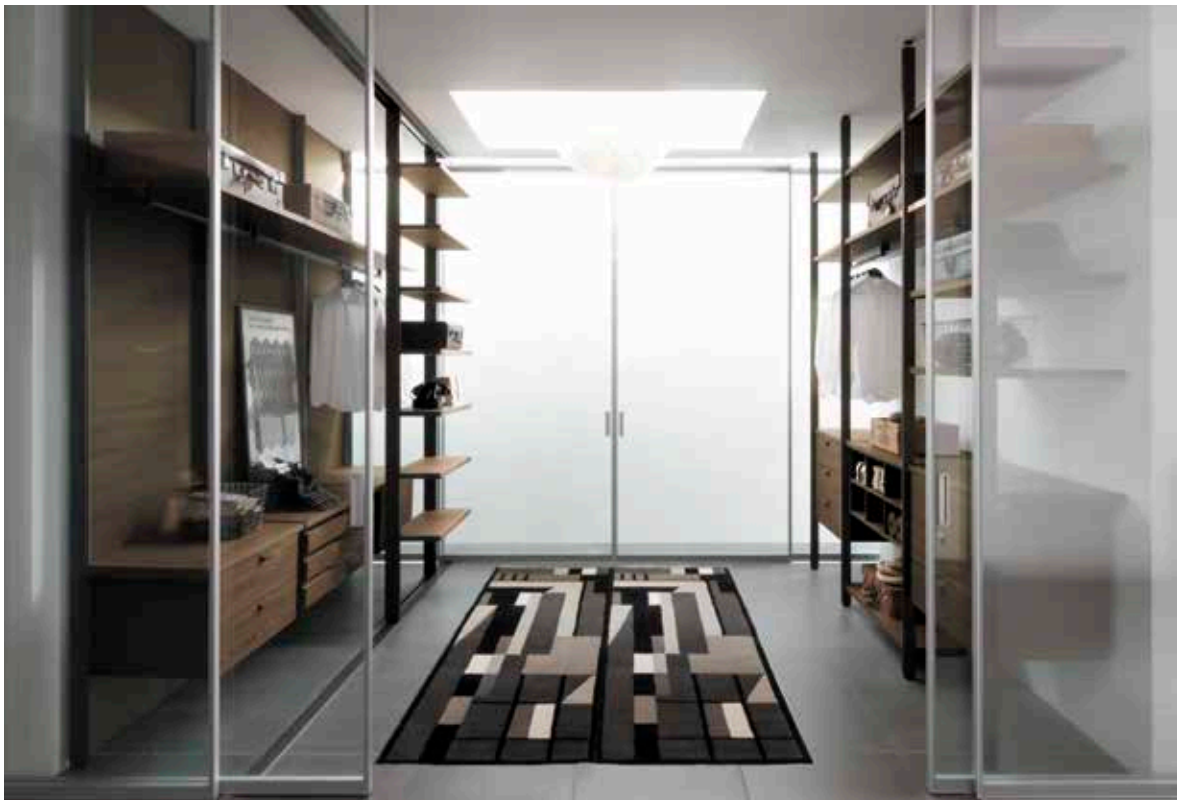

① Mensole e cassettiere in legno noce canaletto | Shelves and drawers in walnut wood | Étagères et tiroirs en bois noyer canaletto | Böden und Schubladen in Holz Nußbaum Canaletto | Estantes y cajoneras en madera nogal americano



① Illuminazione integrata nel montante verticale | Integrated lighting in the vertical profile | Illumination intégré sur le montant vertical |
In dem vertikalen Pfosten integrierte Beleuchtung | Iluminación integrada en el montante vertical



② /

② Cassettiera ad isola | Island chest of drawers | Tiroirs à île | Insel Schubladen | Cajonera à isla

solo

Designed by: CRS albed

Typology: Cabina armadio | Walk-in wardrobe |
Armoire-penderie | Schrank | Vestidor

Una cabina armadio che fa della sua ecletticità il vero punto di forza essendo in grado con semplici accorgimenti tecnici di assecondare l'architettura di una stanza o dividerla diventando free-standing.

A walk-in wardrobe that stands out for its eclectic features. Simple technical adjustments will make it either merge into the architectural layout of a room or act as a partition that divides the room by being placed as a free-standing element.

Une armoire-penderie qui fait de son éclectisme le vrai point fort, étant en mesure grâce à de simples astuces techniques de seconder l'architecture d'une pièce ou de la séparer en devenant free-standing.

Die Stärke dieses begehbaren Schrankes liegt in seiner Vielseitigkeit: dank einfacher technischer Vorrichtungen ist er in der Lage, sich perfekt in ein Zimmer einzufügen oder freistehend als Trennelement zu fungieren.

Un vestidor que convierte su aspecto ecléctico en su verdadera fuerza consiguiendo, con simples soluciones técnicas, moverse al compás de la arquitectura de una habitación, o dividirla para que sea free-standing.





① Montanti e profili in finitura champagne | Profiles in champagne finishing | Montants et profils en finition champagne | Pfosten und Profile in Ausführung Champagne | Montantes y perfiles en acabado champagne

② Ante e schienali in vetro extrachiaro | Doors and backs in extra-clear glass | Porte et dos en verre extraclair | Türen und Rückwände in Klarglas extra hell | Puertas y respaldos en vidrio extra-claro



/ ①

/ ① Ante in vetro extrachiario con tessuto Delux Gold | Doors in extra-clear glass with fabric Deluxe Gold | Portes en verre extra clair avec tissu Delux Gold | Türen in Klarglass extra hell mit Stoffe Delux Gold | Puertas en vidrio extra-claro con tejido Delux Gold



② /

②

Illuminazione integrata nel montante verticale | Integrated lighting in the vertical profile | Illumination intégré sur le montant vertical |
In dem vertikalen Pfosten integrierte Beleuchtung | Iluminación integrada en el montante vertical

Dettaglio dell'abbinamento tra la mensola in cuoio e il telaio perimetrale in alluminio anodizzato finitura champagne.

Detail of the coupling between the leather shelf and the perimetral frame in anodized aluminum champagne finish.

Détail de l'union entre l'étagère en cuir et le cadre périmétrale en aluminium anodisé en finition champagne.

Detail der Kombination zwischen des Bodens in Leder und des Umfangsrahmens in anodisiertem Aluminium Champagne Ausführung.

Detalle de la combinación entre el estante de cuero y el marco perimetral en aluminio anodizado acabado champagne.





solo

pag 100



Soluzione a parete | Upright solution | Solution au mur |
Wandlösung | Solucion a pared

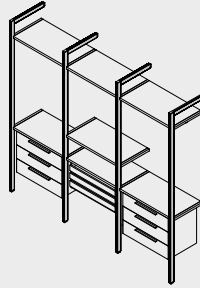

Soluzione a soffitto | Ceiling solution | Solution au
plafond | Decklösung | Solucion a techo

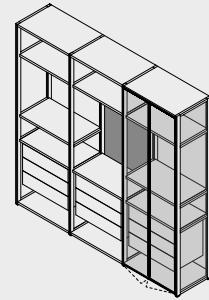

ri-vista

pag 96



Parete attrezzata fissa | Fixed equipped wall | Paroi
équipée fixe | Befestigten Einbauwand | Pared
equipada fija

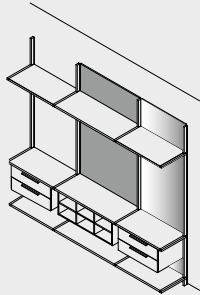

Parete attrezzata scorrevole su binario | Equipped wall
sliding on rails | Paroi équipée coulissante | Einbauwand
auf Schienen | Pared equipada deslizando sobre binarios

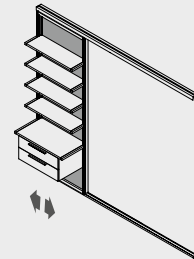

Soluzione freestanding | Freestanding solution | Solution freestanding | Freestanding Version | Solución freestanding

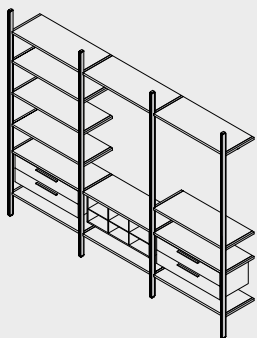

Soluzione in nicchia | Niche solution | Version en niche | Nischenlösung | Solución en nicho

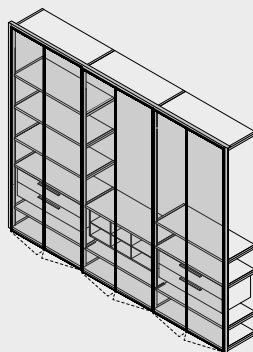

comple menti

Abbiamo scelto di svincolarci dalle pareti declinando alcuni prodotti che raccontassero il nostro essere in maniera indipendentemente; in una sorta di rapporto dialettico tra la necessità di definire il nostro prodotto in un confronto con ciò che all'interno della casa è architettura e ciò che una volta svincolato dall'architettura diventa design.

We have chosen to get free from the walls and to create some products that can tell our being even independently. It is a sort of dialectic relation between the definition of our products and a comparison of what is architecture in a house and what becomes design.

nous avons choisi de nous libérer des murs en déclinant certains produits qui raconteraient notre façon d'être, notamment de manière indépendante, dans une sorte de rapport dialectique entre la nécessité de définir notre produit en nous mesurant avec ce qui relève de l'architecture au sein de la main et ce qui, une fois libéré de l'architecture, devient design.

Durch die „Trennung“ von den Wänden sind einige Produkte entstanden, in denen sich unsere Grundidee auch in unabhängiger Weise ausdrückt, in einer Art dialektischem Verhältnis zwischen dem, was in einer Wohnung als Architektur gilt und was losgelöst von der Architektur zu Design wird.

Hemos decidido abandonar las paredes para diseñar algunos productos que cuenten quiénes somos de forma independiente, mediante una especie de relación dialéctica entre la necesidad de definir nuestro producto, midiéndonos con aquello que en el interior del hogar representa arquitectura y aquello que una vez separado de la arquitectura se convierte en diseño.



vista girevole

Designed by: CRS albed

Typology: Libreria | Bookcase | Librairie |
Buchhandlung | Libreria

La capacità e il talento di Vista nel dividere e organizzare lo spazio nuovamente si esprime e stupisce con contenitori che scorrono e ruotano su se stessi, mostrando, archiviando o nascondendo.

The skill and talent of Vista to divide and organise the space is also expressed by containers that slide and turn around themselves, showing, holding files and hiding.

L'aptitude de Vista à organiser et diviser l'espace apparait aussi avec ces conteneurs qui coulissent, en structurant l'espace.

Die Fähigkeit und Eigenschaft von Vista den Raum zu teilen und neu zu gliedern, äußert sich außerdem durch den Einsatz von Containern, die sich schieben und drehen lassen, und zur Ablage und Archivierung dienen.

La capacidad y la función de Vista es dividir y organizar el espacio y se manifiesta sorprendente a través de contenedores que se deslizan y giran en sus mismos, mostrando y escondiendo.





① Binario ad incasso | Built-in rail | Rail encastré | Eingelassene Schiene | Guía empotrada

line

Designed by: Daniele Lo Scalzo Moscheri

Typology: Libreria | Bookcase | Librarie |
Buchhandlung | Libreria

Il design diventa un pensiero architettonico. Uno schema compositivo libero in cui l'orizzontalità del ripiano diventa strutturale, e lo sviluppo delle altezze segue un principio costruttivo verticale basato su volumi a forte spessore.

Design as architectural thought. A free composition scheme in which the horizontality of the shelf becomes structural, and the development of heights follows a vertical constructive principle based on masses with a strong thickness.

Le design devient une question architecturale. Un schéma de composition libre, où l'horizontalité de l'étagère devient structurelle et le développement des hauteurs suit un principe de construction verticale basé sur des volumes de forte épaisseur.

Design als architektonischer Begriff. Ein freies Aufbauschema, bei dem die horizontale Linie der Einlegeböden strukturbildend wirkt und die Vertikale einem Konstruktionsprinzip folgt, das auf Volumen mit hoher Dicke basiert.

El diseño vuelve a ser un pensamiento arquitectónico. Un esquema compositivo libre en el cual la horizontalidad del estante se hace estructural, y el desarrollo de las alturas sigue un principio constructivo vertical basado en volúmenes de fuertes espesores.





① Struttura in alluminio | Aluminium structure | Structure en aluminium | Aluminiumstruktur | Estructura en aluminio





② Ribalta a scendere h 42 | Flap down door H 42 | Porte relevable vers le bas h 42 | Klapptür nach unten H 42 | Basculante a bajar H 42

nile

Designed by: CRS albed

Typology: Tavolo | Table | Table | Tisch | Mesa

Nile un tavolo dalle linee estremamente semplici adatto sia per lo scenario domestico che per il complesso mondo del contract.

Nile, a table with very simple lines designed to merge into the domestic setting and into the complex world of contract furnishings.

Nile, une table aux lignes extrêmement simples adaptée aussi bien au scénario domestique qu'au monde complexe du contract.

Nile, ein Tisch mit äußerst schlichten Formen, der sowohl für private Wohnräume, als auch für komplexe Contract-Bereiche geeignet ist.

Nile, una mesa con una línea extremadamente sencilla idónea tanto para el escenario doméstico como para el complejo mundo del contract.

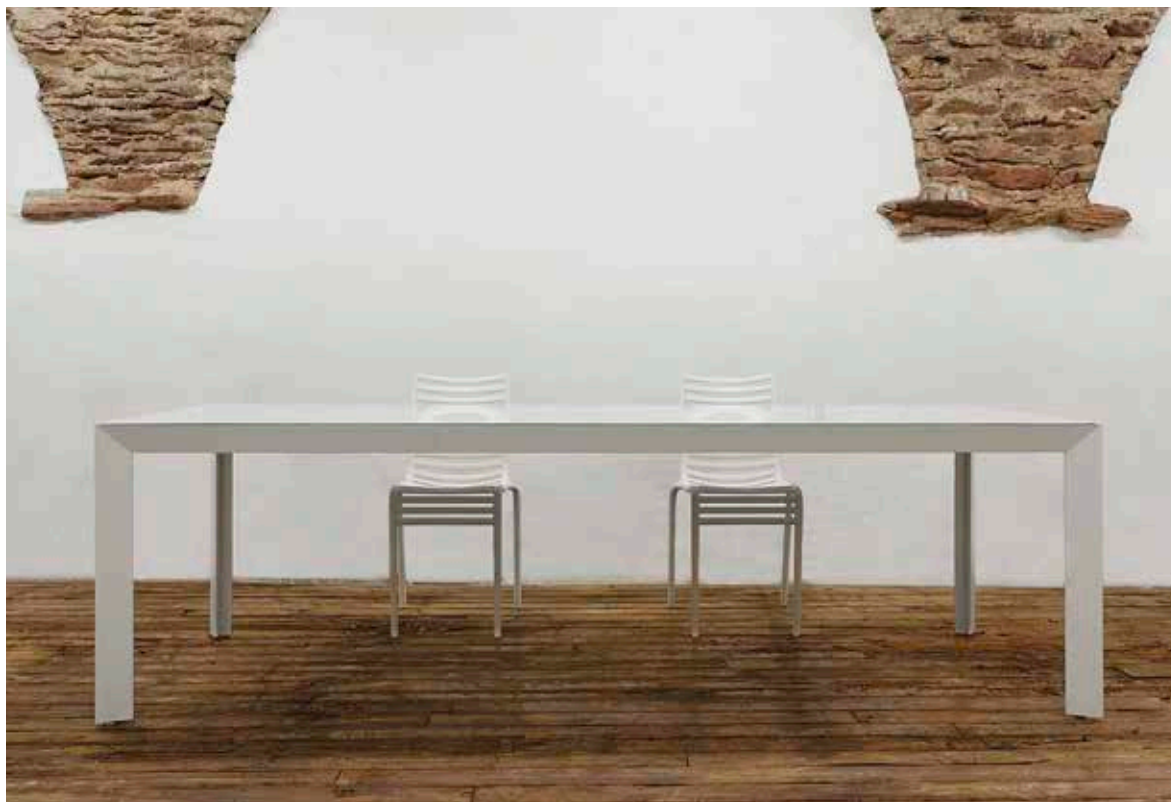



① Struttura in alluminio laccato RAL 7043 | Lacquered RAL 7043 aluminium structure | Structure en aluminium laqué RAL 7043 | Struktur in Aluminium lackiert RAL 7043 | Estructura de aluminio lacado RAL 7043





**vista
girevole**

pag 110



I contenitori ruotano a 360° e scorrono lateral mente | Containers rotate 360° and slide sideways | Conteneurs tournent à 360° et glissent latéralement | Behälter um 360° drehen und schieben seitwärts | Los contenedores rodean de 360° y deslizan hacia los lados

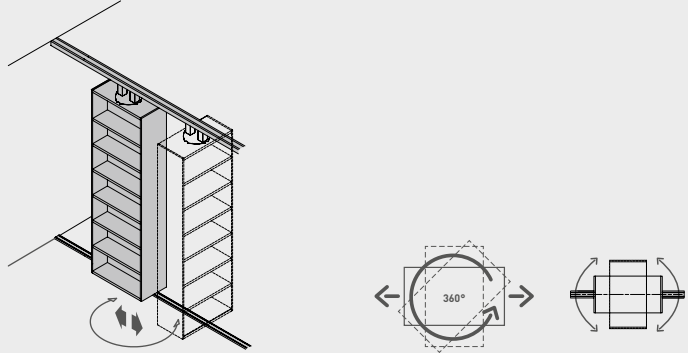

line

pag 112

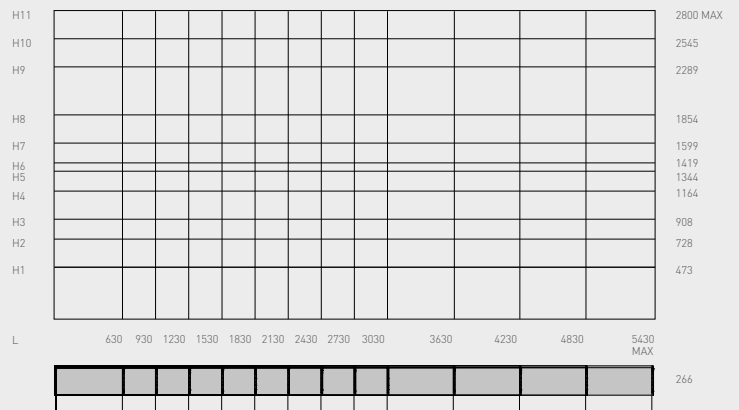
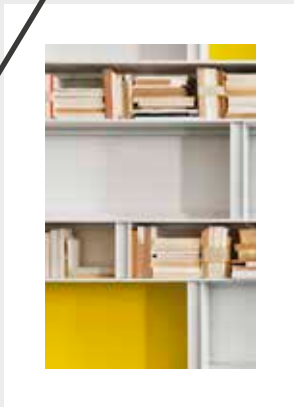

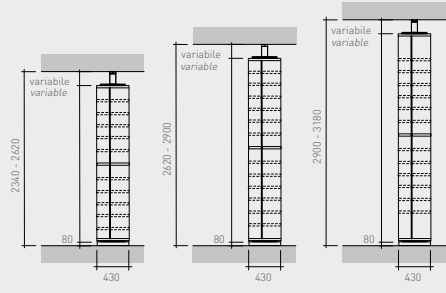

nile

pag 116

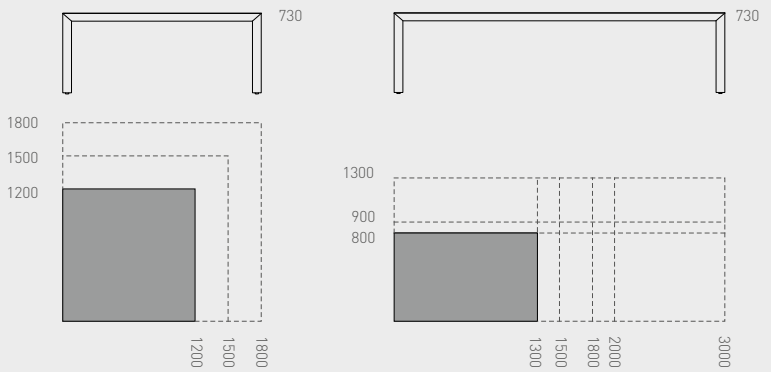

	level	ring	blow	integra	and	next	ri-trait/ 0b	prima	quadra	beat	quinta	dot	sail	all ways	boise	celine	quies	vista girevole	ri-vista	solo	line	mile	
alluminio		■	■				■	■	■	■		■	■	■	■	■	■	■	■	■			
nero							■	■	■		■	■	■	■	■	■	■	■	■	■	■		
bronzo							■	■	■		■	■		■		■	■	■	■	■	■		
champagne							■		■		■	■				■			■	■			
bianco	□			□	□	□				□								□	□	□	□	□	
laccato ral	■			■	■	■				■											■	■	
frassino light										■													
wengè										■													
noce canaletto										■													



































Pannello porta, schienali e accessori | Door jambs, door frame, uprights and table structure | Jambage, cadre de porte, montants et structure de la table | Türpfosten, Türrahmen, Pfosten und Tischstruktur | Jambas, marco de puerta, montantes y estructura de la mesa.

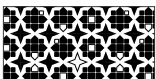

























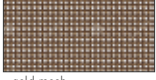







	level	ring	blow	integra	and	next	ri-trait	prima	quadra	beat	quinta	dot	sail	all ways	boise	celine	quies	vista girevole	ri-vista	solo	line	mile
fango				■		■			■						■				■	■		
testa di moro				■		■			■						■				■	■		

	level	ring	blow	integra	and	next	ri-trait/8b	prima	quadra	beat	quinta	dot	sail	all ways	boise	celine	quies	vista girovole	ri-vista	solo	line	nile
laccato ral																						
wengè																						
noce canaletto																						
frassino light																						
frassino lounge																						
frassino carbone																						
frassino grey																						
eucalyptus																						
pino con nodi																						
rovere termotr.																						
bianco acrilico																						
ardesia																						
nobilitato bianco																						
nobilitato louvre																						
nobilitato carbone																						
nob. light forest																						
nob. mid forest																						
nob. dark forest																						

	level	ring	blow	integra	and	next	ri-trait/ 8b	prima	quadra	beat	quinta	dot	sail	all ways	boisé	celine	quies	vista girevole	ri-vista	solo	line	mile
neutro							<input type="checkbox"/>	<input type="checkbox"/>	<input type="checkbox"/>	<input type="checkbox"/>	<input type="checkbox"/>	<input type="checkbox"/>	<input type="checkbox"/>			<input type="checkbox"/>			<input type="checkbox"/>	<input type="checkbox"/>		
acidato						<input type="checkbox"/>	<input type="checkbox"/>	<input type="checkbox"/>	<input type="checkbox"/>	<input type="checkbox"/>	<input type="checkbox"/>	<input type="checkbox"/>	<input type="checkbox"/>			<input type="checkbox"/>			<input type="checkbox"/>	<input type="checkbox"/>		
bianco latte							<input type="checkbox"/>	<input type="checkbox"/>	<input type="checkbox"/>	<input type="checkbox"/>	<input type="checkbox"/>					<input type="checkbox"/>			<input type="checkbox"/>	<input type="checkbox"/>		
neutro extrach.							<input type="checkbox"/>	<input type="checkbox"/>	<input type="checkbox"/>	<input type="checkbox"/>	<input type="checkbox"/>	<input type="checkbox"/>	<input type="checkbox"/>			<input type="checkbox"/>			<input type="checkbox"/>	<input type="checkbox"/>		
specchio	<input type="checkbox"/>			<input type="checkbox"/>			<input type="checkbox"/>	<input type="checkbox"/>	<input type="checkbox"/>	<input type="checkbox"/>	<input type="checkbox"/>				<input type="checkbox"/>	<input type="checkbox"/>			<input type="checkbox"/>	<input type="checkbox"/>	<input type="checkbox"/>	<input type="checkbox"/>
fumè							<input type="checkbox"/>	<input type="checkbox"/>	<input type="checkbox"/>	<input type="checkbox"/>	<input type="checkbox"/>	<input type="checkbox"/>	<input type="checkbox"/>	<input type="checkbox"/>		<input type="checkbox"/>	<input type="checkbox"/>		<input type="checkbox"/>	<input type="checkbox"/>		
bronzo							<input type="checkbox"/>	<input type="checkbox"/>	<input type="checkbox"/>	<input type="checkbox"/>	<input type="checkbox"/>	<input type="checkbox"/>	<input type="checkbox"/>	<input type="checkbox"/>		<input type="checkbox"/>	<input type="checkbox"/>		<input type="checkbox"/>	<input type="checkbox"/>		
acidato extrach.						<input type="checkbox"/>	<input type="checkbox"/>	<input type="checkbox"/>	<input type="checkbox"/>	<input type="checkbox"/>	<input type="checkbox"/>	<input type="checkbox"/>	<input type="checkbox"/>			<input type="checkbox"/>			<input type="checkbox"/>	<input type="checkbox"/>		
fumè acidato						<input type="checkbox"/>	<input type="checkbox"/>	<input type="checkbox"/>	<input type="checkbox"/>	<input type="checkbox"/>	<input type="checkbox"/>	<input type="checkbox"/>	<input type="checkbox"/>	<input type="checkbox"/>		<input type="checkbox"/>	<input type="checkbox"/>		<input type="checkbox"/>	<input type="checkbox"/>		
bronzo acidato						<input type="checkbox"/>	<input type="checkbox"/>	<input type="checkbox"/>	<input type="checkbox"/>	<input type="checkbox"/>	<input type="checkbox"/>	<input type="checkbox"/>	<input type="checkbox"/>	<input type="checkbox"/>		<input type="checkbox"/>	<input type="checkbox"/>		<input type="checkbox"/>	<input type="checkbox"/>		
sfoked reflex						<input type="checkbox"/>	<input type="checkbox"/>	<input type="checkbox"/>	<input type="checkbox"/>	<input type="checkbox"/>	<input type="checkbox"/>	<input type="checkbox"/>	<input type="checkbox"/>			<input type="checkbox"/>			<input type="checkbox"/>	<input type="checkbox"/>		
bronzo reflex						<input type="checkbox"/>	<input type="checkbox"/>	<input type="checkbox"/>	<input type="checkbox"/>	<input type="checkbox"/>	<input type="checkbox"/>	<input type="checkbox"/>	<input type="checkbox"/>			<input type="checkbox"/>			<input type="checkbox"/>	<input type="checkbox"/>		
specchio bronzo	<input type="checkbox"/>			<input type="checkbox"/>			<input type="checkbox"/>	<input type="checkbox"/>	<input type="checkbox"/>	<input type="checkbox"/>	<input type="checkbox"/>				<input type="checkbox"/>				<input type="checkbox"/>	<input type="checkbox"/>	<input type="checkbox"/>	<input type="checkbox"/>
satinato														<input type="checkbox"/>			<input type="checkbox"/>					
trasparente														<input type="checkbox"/>			<input type="checkbox"/>					
neutro reflex							<input type="checkbox"/>	<input type="checkbox"/>	<input type="checkbox"/>	<input type="checkbox"/>	<input type="checkbox"/>	<input type="checkbox"/>	<input type="checkbox"/>			<input type="checkbox"/>						
quarzo	<input type="checkbox"/>		<input type="checkbox"/>				<input type="checkbox"/>	<input type="checkbox"/>	<input type="checkbox"/>		<input type="checkbox"/>				<input type="checkbox"/>	<input type="checkbox"/>						
tortora satinato	<input type="checkbox"/>		<input type="checkbox"/>			<input type="checkbox"/>	<input type="checkbox"/>	<input type="checkbox"/>	<input type="checkbox"/>		<input type="checkbox"/>				<input type="checkbox"/>	<input type="checkbox"/>						
shanghai orizzontale																<input type="checkbox"/>						
shanghai verticale						<input type="checkbox"/>	<input type="checkbox"/>	<input type="checkbox"/>	<input type="checkbox"/>	<input type="checkbox"/>	<input type="checkbox"/>	<input type="checkbox"/>	<input type="checkbox"/>			<input type="checkbox"/>			<input type="checkbox"/>	<input type="checkbox"/>		

	level	ring	blow	integra	and	next	ri-trait / 8b	prima	quadra	beat	quinta	dot	sail	all ways	boisé	celine	quies	vista girevole	ri-vista	solo	line	nile
ardesia satinato	■			■		■	■	■	■	■	■				■	■			■	■	■	■
nero satinato	■			■		■	■	■	■	■	■				■	■			■	■	■	■
quarzo satinato	■			■		■	■	■	■	■	■				■	■			■	■	■	■
senape satinato	■			■		■	■	■	■	■	■				■	■			■	■	■	■
tortora	■			■		■	■	■	■	■	■				■	■			■	■	■	■
ardesia	■			■		■	■	■	■	■	■				■	■			■	■	■	■
nero	■			■		■	■	■	■	■	■				■	■			■	■	■	■
dark grey							■	■	■	■	■	■	■			■						
bianco neve extr.	□			□		□	□	□	□	□	□				□	□			□	□	□	□
neve acidato	□			□		□	□	□	□	□	□				□	□			□	□	□	□
senape	■			■		■	■	■	■	■	■				■	■			■	■	■	■
polvere	■			■		■	■	■	■	■	■				■	■			■	■	■	■
polvere satinato	■			■		■	■	■	■	■	■				■	■			■	■	■	■
verde petrolio	■			■		■	■	■	■	■	■				■	■			■	■	■	■
verde petrolio sat.	■			■		■	■	■	■	■	■				■	■			■	■	■	■

	level	ring	blow	integra	and	next	ri-trait/ 8b	prima	quadra	beat	quinta	dot	sail	all ways	boisé	celine	quies	vista girevole	ri-vista	solo	line	mile	
fumè acidato																							
 riad negativo nero																							
 sophie bianco																							
 tweed grigio																							
 riad nero																							

	level	ring	blow	integra	and	next	ri-trait/ 8b	prima	quadra	beat	quinta	dot	sail	all ways	boisé	celine	quies	vista girevole	ri-vista	solo	line	mile
fabric white																						
fabric black																						
 alu natural mesh																						
 gold mesh																						
 deluxe gold																						
 deluxe silver																						

Mensole in vetro | Door jambs, door frame, uprights and table structure | Jambage, cadre de porte, montants et structure de la table | Türpfosten, Türrahmen, Pfosten und Tischstruktur | Jambas, marco de puerta, montantes y estructura de la mesa

	level	ring	blow	integra	and	next	ri-trait/8b	prima	quadra	beat	quinta	dot	sail	all ways	boisé	celine	quies	vista girevole	ri-vista	solo	line	nile
neutro extrach.																			□	□		
fumè																			■	■		
bronzo																			■	■		
dark grey																			■	■		
acidato																			□	□		
fumè acidato																			■	■		
bronzo acidato																			■	■		

Nell'ottica di un continuo sviluppo del prodotto, la ditta si riserva il diritto di cambiare specifiche, design e materiali in qualsiasi momento e senza preavviso. I colori evidenziati hanno il solo scopo illustrativo e sono tanto accurati quanto il processo di stampa può permettere.

With the aim of a continuous product development, the company reserves the right to change specifications, design and materials at any time and without notice. The colours shown are for illustrative purposes only and they are as accurate as the printing process can permit.

Dans le cadre du développement continu de nos produits, la société se réserve le droit de modifier les détails, design et matériaux sans préavis. Les couleurs sont seulement indicatives et sont le plus proches possible en fonction de ce que l'impression permet.

In Anbetracht daß die Produkte sich immer entwickeln, die Firma sich das Recht vorbehält, Angaben, Design und Materiale fortwährend und ohne Avis zu ändern. Die betonten Farben haben nur erklärende Ziel und sind sorgfältig nach viel der Drucksprozeß erlauben kann.

Desde un punto de vista de un desarrollo continuo del producto, la empresa se reserva el derecho de modificar en cualquier momento y sin previo aviso detalles técnicos, design y materiales. Los colores mostrados tienen una finalidad únicamente ilustrativa y se iguala a la realidad como el proceso de impresión puede permitir.

art director: paolo festa
 graphic project: luca bossi
 printing: galli thierry - marzo 2019

ALBED - Delmonte Srl
 via San Martino
 Nova Milanese - (MB)
 t. +39 0362 367112
 info@albed.it
 www.albed.it

ALBED flagship store
 via S. Damiano 5 - Milano (MI)
 t. +39 02 76340610
 milano@albed.it

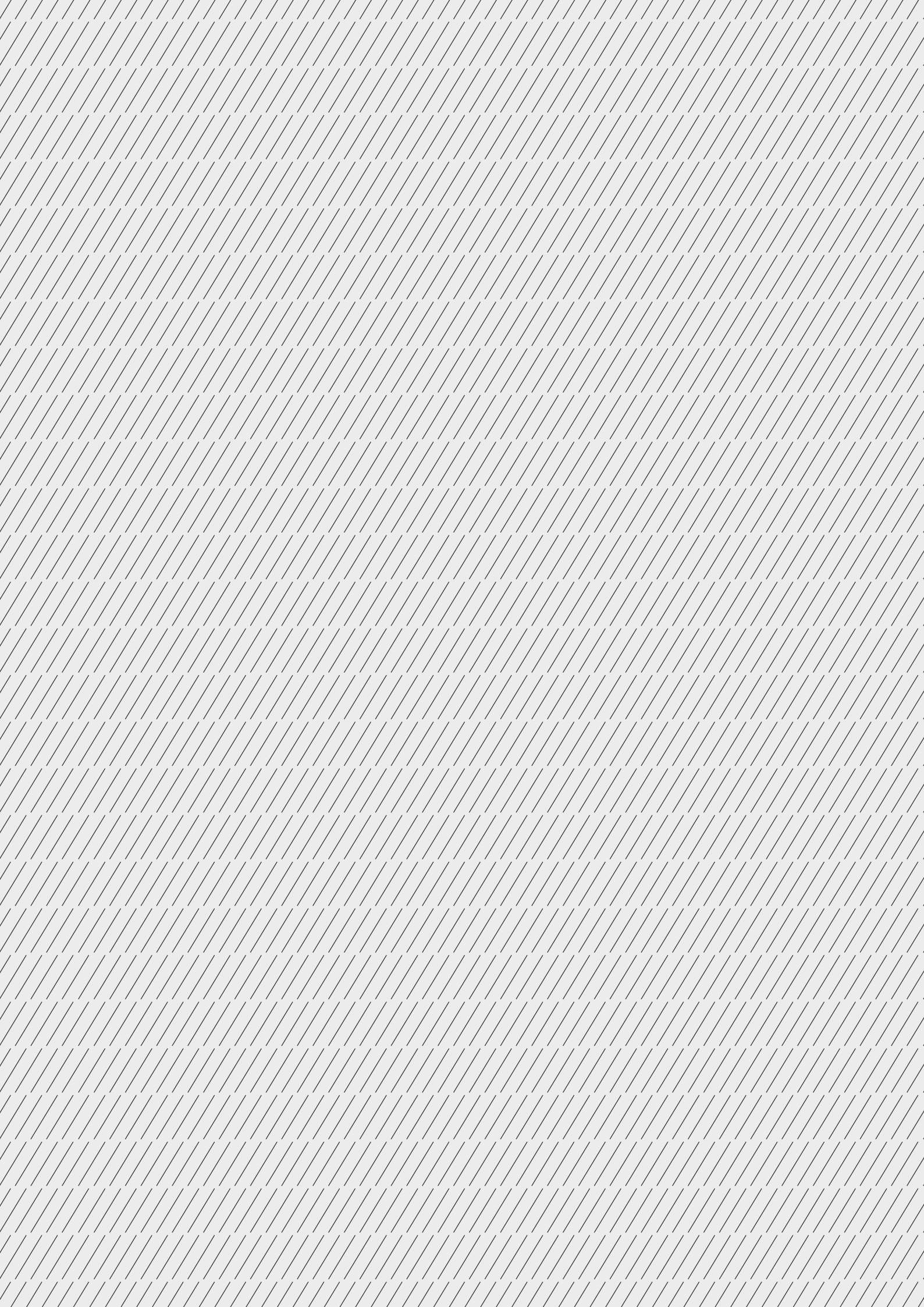

ALBED

MILANO 1964

ALBED - Delmonte Srl
via San Martino
Nova Milanese - (MB)
t. +39 0362 367112
info@albed.it
www.albed.it

ALBED flagship store
via S. Damiano 5 - Milano (MI)
t. +39 02 76340610
milano@albed.it