

Lou
n
ge.

lapalma

Lounge.



Index

PLUS Francesco Rota 2017	13
SCREEN Francesco Rota 2016	31
UNO Francesco Rota 2016	41
KIPU Anderssen & Voll 2014	51
ADD SOFT Francesco Rota 2018	61
PASS Hee Welling 2012	69
YO Romano Marcato 2016	79
ADD Francesco Rota 2014	87
JEY Francesco Rota 2016	105
OORT Francesco Rota 2017	115
AUKI Hee Welling 2015	123
BRIO Romano Marcato 2001	135
ZA SYSTEM Shin & Tomoko Azumi 2003	143

Il lounge di Lapalma

Nuovi scenari della contemporaneità, gli spazi lounge diventano luoghi sempre più condivisi, sempre più trasversali e permeabili. Lounge non sono più soltanto le tradizionali zone di attesa degli aeroporti e degli hotel, ma sono tutti quegli spazi caratterizzati dall'aggregazione e dalla condivisione di persone e azioni.

Sono luoghi aperti e ricettivi, dove le funzioni che vi si svolgono, si assemblano e si moltiplicano. Liberamente.

Nelle lounge contemporanee non "si aspetta" più solamente, assorti nella lettura di un giornale. Si telefona, si lavora, ci si connette con tablet o pc.

E poi ci si incontra, si mangia, si ascolta musica, ci si rilassa. In poche parole, si vive. In un mix funzionale, dove le barriere spaziali si annullano, e devono essere riorganizzate secondo nuove formule.

La lounge si dilata quindi a un nuovo concept funzionale, dove il confine tra comfort domestico e luogo di lavoro si assottiglia fino a scomparire.

Questo nuovo panorama presuppone allora arredi e composizioni spaziali diversi e articolati, dai connotati morbidi e confortevoli, ricchi di dinamismo e colore.

Lapalma anticipa e coglie il cambiamento, progettando famiglie di elementi per un nuovo scenario di interni. Sedute, pouff, tavolini si declinano secondo nuove configurazioni trasversali, ora chiuse ora aperte, ora individuali ora collettive.

Compaiono nuovi accessori – supporti per tablet e tavolini girevoli o fissi – per semplificare l'utilizzo dei device tecnologici.

È la lounge contemporanea di Lapalma: luogo prima di tutto piacevole da vivere.

lounge by Lapalma

In the new scenarios of the contemporary world, lounge areas become places more often shared, transversal and flexible. 'Lounge' encompass not only the traditional waiting areas in the airports and hotels, but all those spaces where people gather and actions can be shared. These are open and friendly spaces, where functions can be shared and participated in freely. In the lounge you do not just "wait" reading a newspaper: you can phone, work, use your tablet or pc. You meet people, you can eat, listen to music, relax, in few words, you live in a functional mix where obstacles are cancelled and spaces reconfigured to meet the new needs. The lounge expands itself in new functional concepts where the boundaries between domestic comfort and working place are thinner or even vanished. It follows then that this new landscape needs different furniture, soft and comfortable, dynamic and colorful. As flexible as the spaces they inhabit. Lapalma recognizes this change and designs families of products for this new scenario. Seating systems, ottomans, tables are developed in new transversal arrangements, sometimes closed, sometimes open, individual or collective. New accessories -case for tablet, swiveling tops- are available to use in a way to satisfy the mix of functions. This is the contemporary lounge of Lapalma: a friendly space to live in.

lounge von Lapalma

Neue Szenarien der modernen Welt: Loungebereiche werden immer mehr zu gemeinschaftlich genutzten Räumen, immer wandelbarer und durchlässiger. Unter Lounge verstehen wir nicht mehr nur die traditionellen Wartebereiche an Flughäfen oder in Hotels, sondern alle Räume, in denen sich viele Menschen aufhalten und die von diesen für die unterschiedlichsten Tätigkeiten genutzt werden. Es sind Empfangsräume, in denen sich die unterschiedlichsten Tätigkeiten entfalten, parallel zueinander oder ineinander verwoben. Ganz frei. In den heutigen Loungebereichen wartet man nicht nur in die Lektüre einer Zeitung vertieft. Man telefoniert, arbeitet, benutzt Tablet oder PC, hält eine Videokonferenz. Aber nicht nur das: man begegnet sich, isst, hört Musik, entspannt sich. Kurz gesagt, man lebt. In einer Mischung aus Tätigkeiten, wo sich die Grenzen der Räume aufheben und nach anderen Regeln neu gestaltet werden müssen. Die Lounge wird somit zu einem neuen funktionellen Konzept, wo die Grenze zwischen Wohnraum und Arbeitsplatz immer feiner wird und teilweise sogar ganz verschwindet. Das Alles setzt Einrichtungsgegenstände und Raumgestaltungen voraus, die den veränderten Anforderungen Rechnung tragen. Lapalma erkennt diese Veränderungen und nimmt sie vorweg mit der Entwicklung von Einrichtungs-elementen für neue Raumgegebenheiten. Sitzmöbel, Polsterhocker und Tischchen lassen sich in wandelbaren Konfigurationen, offen oder geschlossen, einzeln oder als Sitzgruppen, zusammenstellen. Neues Zubehör -Tablethalter, drehbare oder fixe Tischchen- wird entworfen, um die Nutzung der modernen Kommunikationsmittel bequemer und einfacher zu gestalten. Bei Lapalmas Lounge geht es vor allem um eines: einen lebenswerten Ort zu schaffen.

lounge de Lapalma

Nouveaux théâtres de la contemporanéité, les espaces lounge deviennent des espaces partagés, transversaux et transparents. Le lounge ce n'est plus seulement la salle d'attente des aéroports ou des hôtels, mais tous les espaces caractérisés par la réunion de personnes et d'actions. Il s'agit de lieux ouverts et réceptifs dans lesquels les fonctions s'assemblent et se multiplient en liberté. Dans les lounges contemporains on n'attend plus simplement en lisant un journal: on téléphone, on travaille, on utilise une tablette ou un ordinateur ou l'on fait une vidéo-conférence. Pas seulement ! on se rencontre, on mange, on écoute de la musique, on se relaxe: en un mot, on vit. Le tout dans un espace mixte et pertinent où les barrières spatiales s'annulent et doivent être remodelées selon de nouveaux schémas. Le lounge se démultiplie à travers de nouveaux concepts fonctionnels où la frontière entre le confort domestique et le lieu de travail diminue jusqu'à disparaître. Ce nouveau panorama pré-suppose alors des meubles permettant des configurations spatiales variées et modulables qui s'adaptent à ces nouvelles exigences. Lapalma anticipe et saisit le changement, en élaborant des familles de produits modulables et complémentaires pour de nouveaux scénarios d'aménagements intérieurs: des assises, des poufs, des tables basses qui se déclinent selon de nouvelles configurations transversales, ouvertes ou fermées, individuelles ou collectives; de nouveaux accessoires apparaissent – supports pour tablettes, tops pivotants ou fixes – pour simplifier l'utilisation des appareils digitaux. Un espace agréable à vivre : c'est le lounge contemporain de Lapalma.

lounge por Lapalma

Nuevos escenarios contemporáneos, espacios lounge se convierten en lugares cada vez más de intercambio, siempre más transversales y permeables. Las salas lounge no son sólo las tradicionales zonas de espera en aeropuertos y hoteles, pero son espacios que se caracterizan por la agregación y el intercambio de personas y acciones. Son lugares abiertos y receptivos, donde las tareas que tienen lugar allí, se ensamblan y se multiplican libremente. En la sala lounge contemporánea, no se "espera" más simplemente, absorbido por la lectura de un periódico. Nos comunicamos, se trabaja, se utiliza el tablet o el portátil, se realiza una videoconferencia. Pero no sólo eso: nos reunimos, se come, escuchamos música, nos relajamos. En pocas palabras, se vive. Una mezcla funcional, donde las barreras del espacio se anulan, y deben ser reorganizados de acuerdo a nuevas fórmulas. La sala lounge se expande a un nuevo concepto funcional donde la frontera entre la comodidad doméstica y el lugar de trabajo es cada vez menor y con el tiempo desapareceran. Este nuevo escenario requiere mobiliario y composiciones de espacio diferentes, estructurados; que sostengan nuestras necesidades cambiantes. Lapalma anticipa y acoje el cambio, proyectando familias de elementos para un nuevo escenario de interiores. Sillones, sillas, sofás, pufs, mesas se mezclan de acuerdo a las nuevas configuraciones trasversales, hay veces cerradas otras abiertas, privadas o públicas. Aparecen nuevos accesorios – soportes para tablets, mesas giratorias, mesas fijas - para simplificar el uso de dispositivos tecnológicos. La sala lounge contemporánea Lapalma: es un lugar agradable para vivir y compartir.

Passione sostenibile

Lapalma ha da sempre mostrato una grande attenzione all’ambiente. Dalla fabbrica alla selezione dei materiali utilizzati. L’azienda seleziona essenze certificate FSC e controllate fin dalla loro origine; materie prime e materiali totalmente riciclabili quali legno, acciaio, multistrato e tessuto. È ridotto al minimo l'utilizzo di materie plastiche e sono scelti fornitori preferibilmente nelle vicinanze, per evitare trasporti e percorsi su lunghe distanze. L’attenzione all’ambiente è un valore ormai intrinseco e condiviso all’interno dell’azienda, fattore che ha permesso a Lapalma di ottenere importanti certificazioni rilasciate dall’ente tedesco Tüv: la ISO EN 9001, che premia l’efficienza e la qualità del ciclo produttivo e la ISO EN 14001 che ne riconosce il rispetto ambientale.

Per quanto riguarda lo stabilimento, agli 11000 mq

esistenti se ne sono aggiunti 3200. Oltre ai pannelli fotovoltaici che assicurano una completa autonomia energetica, sono state adottate nuove misure legate alla sostenibilità: le sonde geotermiche permettono ora di sfruttare il calore del sottosuolo per il riscaldamento e condizionamento a pavimento in tutta l’azienda, riducendo così i consumi di gas; le lampade tradizionali sono state sostituite con lampade LED in tutti i reparti; sono stati introdotti macchinari di ultima generazione (in particolare il nuovo impianto per tagliare il tubo in metallo con sistema a laser-fibra ottica, anziché laser tradizionale) che permettono di risparmiare energia anche del 50%. Ridurre l’impatto ambientale, grazie alla diminuzione delle emissioni di CO2 e continuare ad investire in innovazione sono le sfide che Lapalma affronta quotidianamente con impegno e passione.

Sustainable Passion

Here at Lapalma, we have always shown a commitment to the environment, from the way we run our factory through to the materials that we use in it. We select only FSC-certified timber from sustainable sources, employ 100% recyclable raw materials - wood, steel, plywood panels and fabrics - and make minimum use of plastics. Our suppliers are preferably chosen in the neighborhood, to avoid long distances.Concern for the environment is an intrinsic part of Lapalma’s operations and is a value that is embraced by the whole company. As a result of our efforts, German certification body Tüv has certified our production system to EN ISO 9001 standard for efficiency and quality and to EN ISO 14001 standard for environmental compatibility. Our new headquarters of 11.000 square meters, have recently been expanded with an extra 3.200 square meters. Along with photovoltaic panels on the roof, giving enough energy for our operations, geothermal probes have been adopted to exploit the underground heath for floor heating and air-conditioning in the whole factory. Old lighting has been superseded by new LED lights and machineries of the latest generation (especially a new laser machine with optic fiber instead of traditional a one) have been introduced to save energy up to 50%. Our efforts to minimize environmental impact by cutting CO2 emissions and to continue investing in innovation are challenges we face each day with renewed commitment and passion.

Nachhaltige Leidenschaft

Lapalma legt seit jeher viel Wert auf Umweltschutz: dies kommt sowohl bei der Auswahl der Materialien als auch bei der Gestaltung des Firmensitzes zur Geltung.Das Unternehmen wählt für seine Produkte nur FSC-zertifiziertes Holz oder Materialien wie Stahl, Multiplex oder Stoff, die vollständig recycelbar sind. Lapalma reduziert die Verwendung von Kunststoffen auf ein Minimum und bevorzugt Zulieferer aus der Region, um lange Transportwege zu vermeiden. Die Achtung der Umwelt ist einer der Grundwerte des Unternehmens, wodurch Lapalma wichtige Zertifikationen, wie das deutsche TÜV-Siegel erlangen konnte: EN ISO 9001 prämiert Effizienz und Qualität des Produktionszyklus und EN ISO 14001 bescheinigt die Umweltfreundlichkeit des Unternehmens. Der Firmensitz von 11.000 Quadratmetern wurde kürzlich um weitere 3.200 Quadratmeter erweitert. Neben Solarpaneelen, die den gesamten Energiebedarf decken, hat Lapalma weitere Maßnahmen zum Umweltschutz eingeleitet und nutzt nun auch geothermische Energie: über eine Sonde wird Luft aus dem Untergrund in ein System eingeleitet, das sowohl als Heizung als auch als Klimaanlage funktioniert. Dadurch wurde der Verbrauch an Erdgas drastisch gesenkt. Die traditionellen Lampen wurden in allen Abteilungen durch LED-Leuchten ersetzt. Des Weiteren arbeitet Lapalma mit Maschinen auf dem neuesten technischen Stand der Dinge: insbesondere wurde ein Glasfaseraserscheider für die Verarbeitung von Metallstäben angeschafft, der im Vergleich zu einem traditionellen Laserschneider fast 50% weniger Strom benötigt. Reduktion des CO2- Ausstoßes und Investition in neue, innovative Technologien: diesen Herausforderungen stellt sich Lapalma jeden Tag mit viel Leidenschaft und Energie und leistet so einen wesentlichen Beitrag zum Umweltschutz.

Passion soutenable

Lapalma a toujours accordé une grande attention à l’environnement, qu’il s’agisse de l’usine ou du choix des matériaux utilisés. L’entreprise sélectionne des essences de bois certifiées FSC contrôlées dès leur origine, des matières premières et des matériaux totalement recyclables comme le bois, l’acier, le multiplis et le tissu. Elle réduit au minimum l’emploi de matières plastiques et les fournisseurs sont choisis en fonction de leur proximité avec l’usine pour éviter les transports sur de longues distances. L’attention à l’environnement est désormais une valeur intrinsèque et partagée au sein de l’entreprise. Ce facteur a permis à Lapalma d’obtenir d’importantes certifications, délivrées par l’organisme allemand Tüv: le label EN ISO 9001, qui récompense l’efficacité et la qualité du cycle de production, et le label EN ISO 14001 qui reconnaît le respect de l’environnement dont fait preuve la société. Au nouveau siège de l’entreprise de 11.000 m², 3.200 autres m² ont été ajoutés, et grâce à l’installation de panneaux photovoltaïques, la totalité des besoins électrique est couverte. De plus, pour être en cohérence avec notre philosophie, des sondes géothermiques ont été installées qui ont permis d’exploiter la chaleur du sous-sol qui sert à chauffer toute l’usine par le sol ainsi que le système d’air conditionné. Les anciennes ampoules ont été substituées par des lampes à LED et les nouvelles machines de la dernière génération (en particulier pour couper le tube métallique avec un système laser à fibre optique au lieu du système traditionnel) permettent une économie d’énergie jusqu’à 50%. Réduire l’impact sur l’environnement, grâce à la diminution des émissions de CO2, et continuer à investir dans l’innovation, voilà le défi que Lapalma relève chaque jour avec application et passion.

Pasión sostenible

Lapalma ha siempre demostrado una gran sensibilidad hacia el medio ambiente. Desde la fabricación hasta la selección de los materiales que utiliza. La empresa opta por maderas certificadas FSC y controladas desde su origen; materias primas y materiales totalmente reciclables como madera, acero, contrachapado y tela. Se reduce al mínimo el uso de materias plásticas; los proveedores son elegidos preferentemente en el cercanías, para evitar el transporte de largas distancias. La sensibilidad hacia el medio ambiente es un valor intrínseco y compartido por todos los que hacemos esta empresa, un factor que ha permitido a Lapalma obtener importantes certificaciones emitidas por el ente alemán Tüv: la EN ISO 9001, que premia eficiencia y calidad del ciclo productivo y la EN ISO 14001 que reconoce el respeto por el medio ambiente. En cuanto a la nueva sede, 3.200 m² que se suma a los 11.000 m² ya existentes. Además de los paneles fotovoltaicos, que aseguran una autonomía energética total, Lapalma ha adoptado por nuevos medios relacionados con la sostenibilidad: sondas geotérmicas que permiten de utilizar el calor de la tierra para la calefacción y refrigeración del piso en toda la empresa, reduciendo así el consumo de gas; las lámparas tradicionales fueron sustituidas por lámparas LED en todos los sectores; se introdujeron maquinarias de última generación (en particular, la nueva maquina para cortar tubos de metal con el sistema de láser-fibra óptica, en lugar de láser tradicional), permitiéndonos además de ahorrar energía de hasta un 50 por ciento. Reducir el impacto medioambiental, gracias a la disminución de las emisiones de CO2 y continuar a invertir en innovación son el desafío que Lapalma afronta día a día con compromiso y pasión.

Morbido e accogliente, il divano PLUS si compone di moduli dalle forme avvolgenti e senza spigoli, per un modo soft e leggero di abitare, o di vivere gli spazi lounge.

Due le caratteristiche principali: un semplicissimo sistema di aggancio tramite staffe a incastro permette soluzioni flessibili e ogni volta diverse; l'elemento SCREEN, divisorio dalla forma accogliente, aggrega e separa gli spazi, diventando un moderno schienale che avvolge il divano seguendone la curva.

Molte le combinazioni che permettono di personalizzare a piacere questo divano, sia per la casa sia per il contract, grazie a elementi di diversa altezza e profondità, agli accessori OORT e alle diverse scelte cromatiche.

Una soluzione di relax e comodità.

Soft and welcoming, PLUS sofa is made up of elements with rounded shapes, for a comfortable way of living at home or in a lounge area. The two main characteristics are, an extremely simple linking system with brackets for flexible configurations and the introduction of the SCREEN partition that can divide spaces or create subtle privacy or become a kind of backrest which surrounds the sofa following its curve. Creating many permutations of tailored configurations for residential environments or a public areas, using elements with different height and depths, additional cushions OORT and a wide palette of colour. A comfortable and relaxing solution.

Weich und einladend: das Sofa PLUS besteht aus Modulen mit großzügigen, runden Formen, die sowohl in Wohnräumen als auch in Loungezonen für Komfort sorgen. Die Hauptmerkmale sind: ein einfaches Verbindungssystem aus Metallbügeln, das flexible und veränderbare Lösungen ermöglicht; das Trennwandsystem SCREEN folgt mit seiner Form den Rundungen des Sofas und schafft gleichzeitig eine Begrenzung zum umgebenden Raum. Das Sofa bietet eine große Gestaltungsfreiheit: die einzelnen Elemente mit verschiedenen Höhen und Tiefen lassen sich nach persönlichem Geschmack zusammenstellen und farblich aufeinander abstimmen sowie mit den Kissen OORT kombinieren. Ein optimale Lösung, die Komfort und Entspannung garantiert.

Souple et accueillant, le canapé PLUS est composé de formes enveloppantes et sans angles vifs suscitant une façon d'habiter soft et légère qui permet une vie agréable soit à la maison soit dans les espace lounge. PLUS présente deux caractéristiques principales: un système d'union très simple constitué par de cornières emboitables qui permettent des solutions flexibles et chaque fois différentes, et l'élément SCREEN, séparation de forme accueillante, qui peut réunir ou partager les espaces, ou suivre la forme arrondi du canapé et devenir un dossier. Plusieurs combinaisons permettent de personnaliser ce canapé qui s'adapte aussi bien aux espaces privés qu'au marché contract, grâce à ses éléments de différentes hauteurs et profondeurs, aux accessoires OORT et aux différents choix chromatiques. Une solution pour un confort relax et détendu.

Suave y acogedor, el sofá PLUS compuesto por módulos de formas redondeadas y sin bordes, para una vida ligera y forma diversa de vivir los espacios lounge. Dos las características principales: un sistema simple de union con abrazaderas a encaje permiten soluciones flexibles y diferentes; el elemento SCREEN, divisor con su forma acogedora, agrega y separa los espacios, convirtiéndose en un respaldo moderno que envuelve el sofá siguiendo la curva. Muchas las combinaciones permiten de personalizar este sofa, que sea para el hogar o el contrato, gracias a los elementos de diferentes alturas y profundidades, a los accesorios OORT y a las opciones cromaticas de color.





yo side table

kipu pouf

plus classic curved – big oort cushion

plus vis-à-vis – big oort cushion

add s storage



kipu pouf jey side table plus classic curved – big oort cushion

yo side table

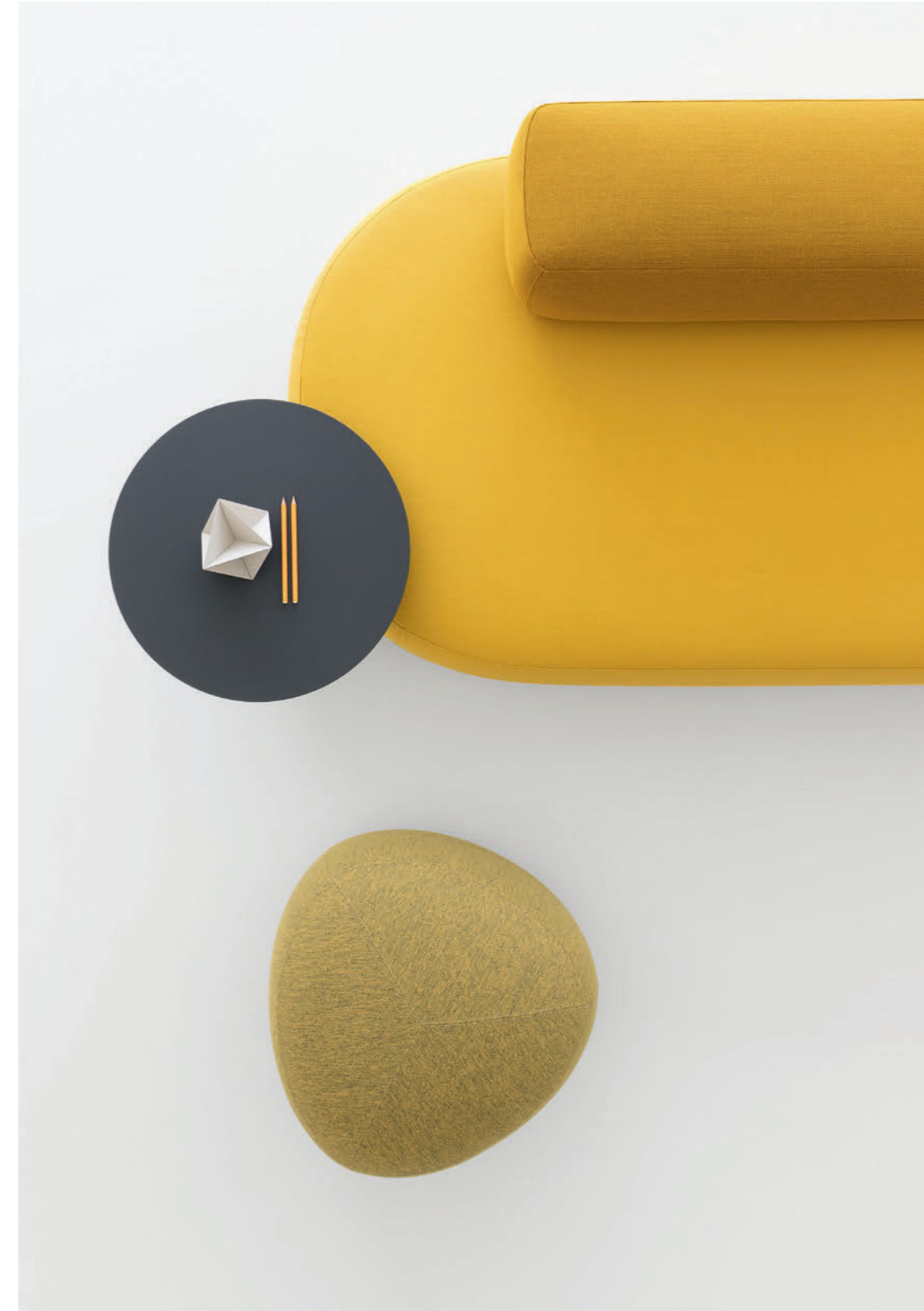

plus classic curved – big kipu pouf jey side table



plus island oort cushion yo side table jey side table

giro stool



plus island oort cushion yo side table jey side table



plus classic oort cushion jey side table

uno lounge chair kipu pouf add s storage



plus classic oort cushion auki coffee table



add s storage uno lounge chair

jey side table yo side table

plus island - big

kipu pour



plus vis-à-vis – big jey side table



PLUS

pass lounge chair plus S_shape – big brio table oort cushion

kipu pouf jey side table



plus L_shape - 5 oort cushion

jei side table

add coffee table

auki coffee table

yo side table

kipu pouf

auki lounge chair



plus pouf jey side table yo side table



Sistema modulare completamente sfoderabile, composto da vari elementi in poliuretano espanso ignifugo. Il sistema si compone di sedute, schienali, braccioli e tavolino che possono essere uniti mediante staffe di giunzione. PLUS si abbina con sistema di divisori SCREEN e gli accessori OORT.

Modular seating in fire-retardant injected foam with removable fabric. Seats, backrests and armrest, also with hpl or wooden top, can be linked. PLUS can be matched with SCREEN partitions and OORT cushions.

Modulares Sitzsystem mit abziehbarem Bezug. Das System umfasst verschiedene Elemente wie Sitzelemente, Rücken- und Armlehnen oder Tischelemente. Diese sind aus feuerhemmendem Polyurethanschaum und können mittels Metallbügeln miteinander verbunden werden. PLUS kann mit den Trennwänden SCREEN oder den Kissen OORT kombiniert werden.

Système d'assises modulaires composé de plusieurs éléments en polyuréthane ignifugé: assises, dossiers, accoudoirs, aussi avec top en hpl ou bois, peuvent être unis par des platines en métal. Les modules sont déhoussables. PLUS peut être intégré avec les cloisons SCREEN et les coussins OORT.

Sistema modular con el tapizado completamente extraíble, compuesto de varios elementos en poliuretano ignífugo. El sistema consiste en asientos, respaldos, apoyabrazos y mesas que se pueden unir mediante abrazaderas de unión. PLUS se combina con el divisor SCREEN y los accesorios OORT.



Rivestimento
tessuto



pelle
ecopelle



Piano
HPL Fenix® nero 10 mm
HPL Fenix® bianco 10 mm



rovere sbiancato
nero poro aperto

Upholstery
fabric

soft-leather
ecoleather

Top
HPL Fenix® black 10 mm
HPL Fenix® white 10 mm

blanched oak
black open pore

Polsterung
Stoff

Softleder
Kunstleder

Platte
HPL Fenix® schwarz 10 mm
HPL Fenix® weiß 10 mm

Eiche gebleicht
schwarz gebeizt offenporig

Revêtement
tissu

peau
peau synthétique

Plateau
HPL Fenix® noir 10 mm
HPL Fenix® blanc 10 mm

chêne blanchi
noir pore ouvert

Revestido
tejido

piel
ecopiel

Encimera
HPL Fenix® negro 10 mm
HPL Fenix® blanco 10 mm

roble blanqueado
negro poro abierto

Side table

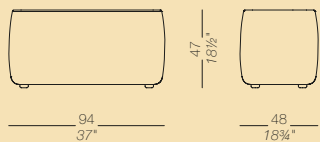

Armrest

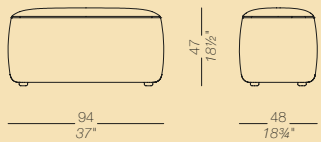

Lounge seats

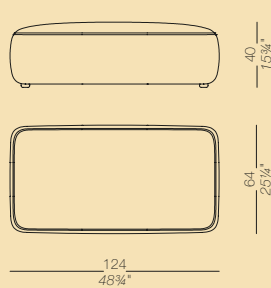
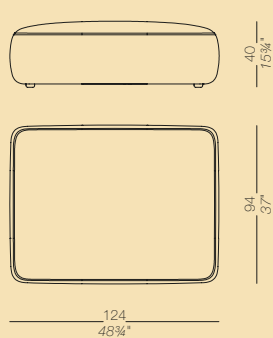
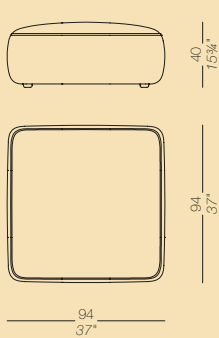
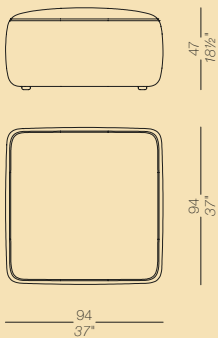
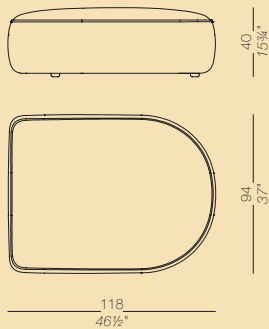
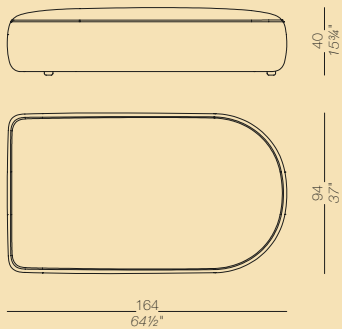

Lounge backrests

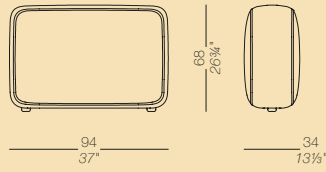
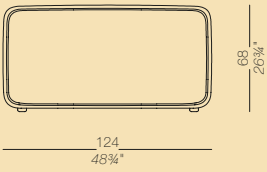

Movable backrest

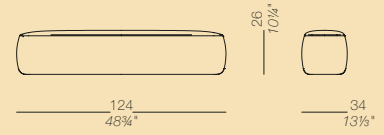

Screen backrests

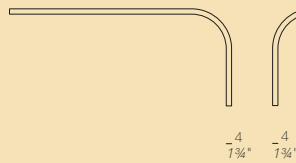
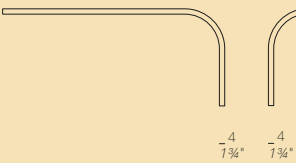
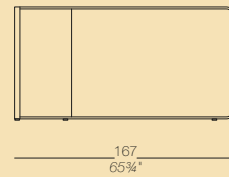
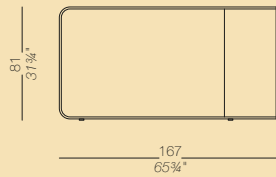
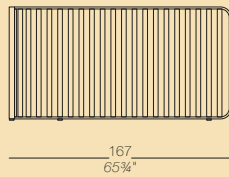
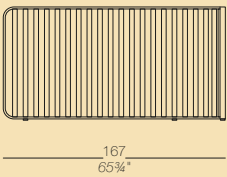

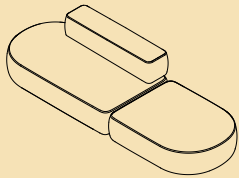

Classic curved

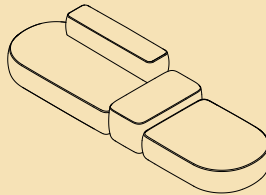

Classic curved — medium

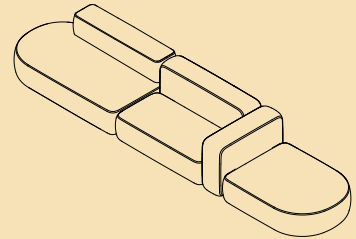

Classic curved — big

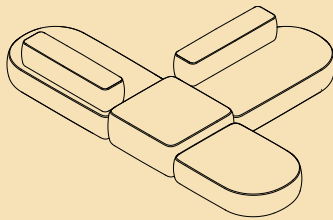

T_shape

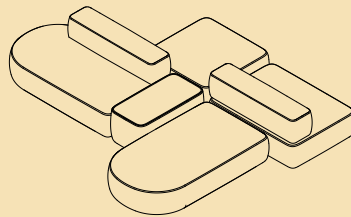

Island

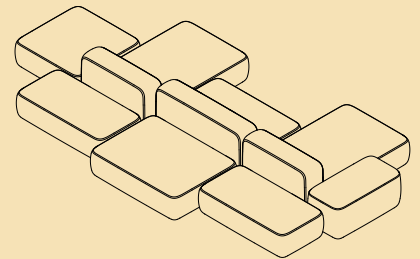

Island — big

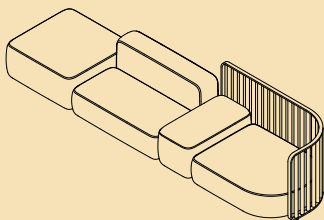

Classic curved — big + screen

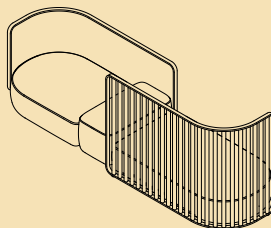

Vis-à-vis

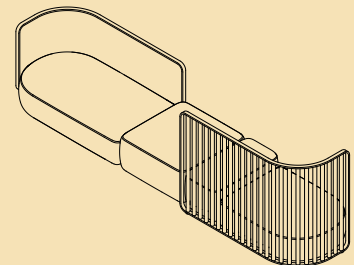

Vis-à-vis — big

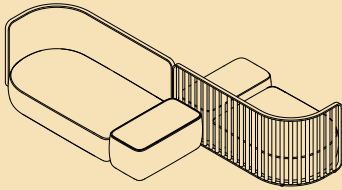

S_shape

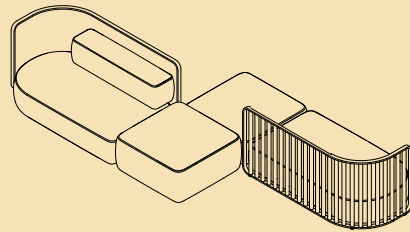

S_shape – medium

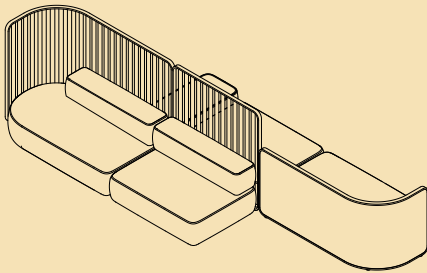

S_shape – big

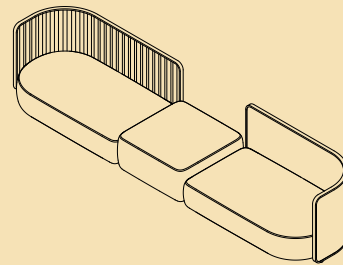

Side by side

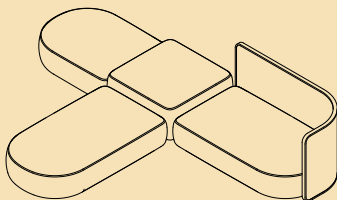

T_shape + screen

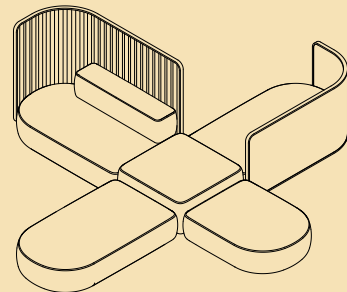

X_shape + screen

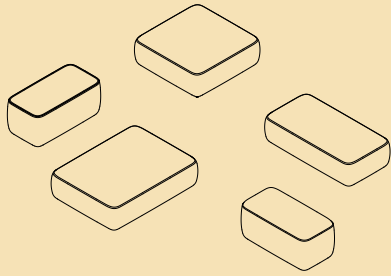

Pouf

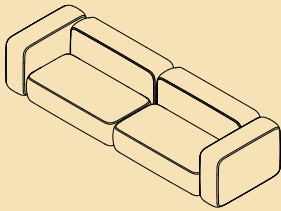

Classic

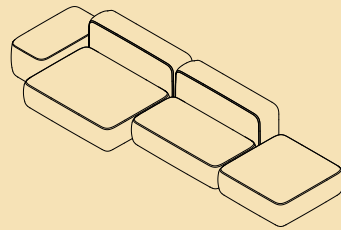

Classic – medium

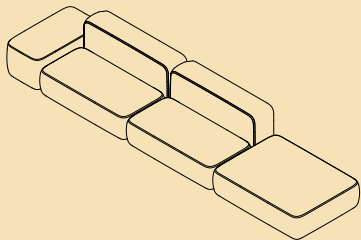

Classic – big

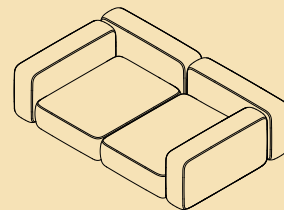

Classic – deep

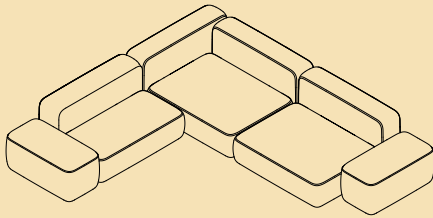

L_shape

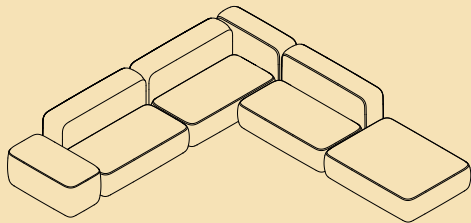

L_shape - 2

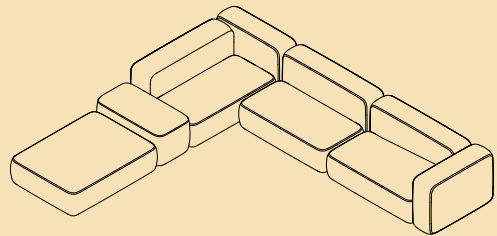

L_shape - 3

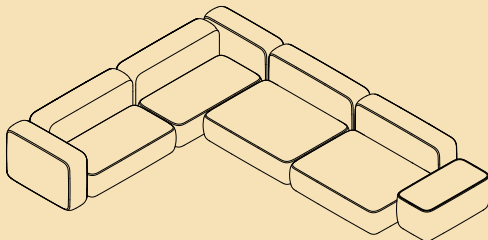

L_shape - 4

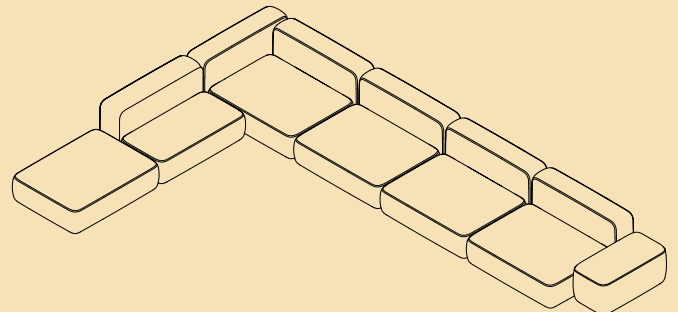

L_shape - 5

I pannelli divisori SCREEN – lineari o curvi – offrono la possibilità di creare, negli open space, delle zone riservate e protette, flessibili, modificabili e facilmente adattabili a ogni situazione.

Angoli come curve accoglienti, pannelli pieni o formati da tubi in essenza o verniciati, delimitano lo spazio facendo passare la luce.

Un sistema di aggancio a calamita facilita la componibilità degli elementi, secondo diverse configurazioni. Il modulo free-standing è sostenuto da semplici basi d'appoggio che conferiscono stabilità al pannello.

The SCREEN partitions, straight or curved, can be used to create privacy in open spaces: they are flexible, re-configurable and are versatile enough to adapt in many environments. With welcoming curves, soft panels or metal tubes powder coated or wood veneered, SCREEN clearly defines the space but does not disturb the perspective. Several configurations are possible using the magnets. The free-standing panel has extra feet for more stability.

Die Trennwände SCREEN - gerade oder gebogen - bieten die Möglichkeit auch in großen, offenen Räumen, Bereiche abzutheilen und Privatsphäre zu schaffen. Gleichzeitig sind sie leicht verschiebbar und die Raumteilung lässt sich nach Bedarf verändern. Die gebogenen Elemente mit Stoffbezug schaffen gemütliche Ecken; die mit lackierten oder holzfurnierten Metallstäben versehenen Trennwände begrenzen den Raum, lassen aber gleichzeitig Licht hindurch. Das Verbindungssystem mittels Magneten garantiert Gestaltungsfreiheit. Das freistehende Modul ist mit Füßen ausgestattet, die für Stabilität sorgen.

Les cloisons SCREEN-droits ou courbes- donnent la possibilité de créer des endroits privés, flexibles et composables dans les open space. Les angles sont arrondis. Les panneaux pleins ou composés de tubes en bois ou métal peuvent délimiter l'espace en laissant passer la lumière. Le système de jonction avec aimants permet une grande facilité et rapidité pour modifier et faire évoluer les configurations. Le module simple peut être aussi autoportant grâce aux pieds en métal.

Los paneles divisores SCREEN, lineales o curvos, ofrecen la posibilidad de crear en espacios abiertos, áreas reservadas y protegidas, flexibles, modificables y fácilmente adaptables a cualquier situación. Las curvas angulares son acogedoras, paneles rellenos, tubulares o lacados a polvo, delimitan el espacio dejando pasar la luz. Un sistema de union a travez de uniones magneticas facilitan la modularidad de los divisores de acuerdo a las diferentes configuraciones. El divisor lineal es autónomo sostenido por una simple base de metal que da estabilidad al panel.





screen space divider



screen space divider **auki** lounge chair **jey** side table

kipu pouf **yo** side table



plus T_shape + screen

jeu side table kipu pouf



SCREEN



screen space divider

uno lounge chair oort cushion jeu side table

olo chair fork table



screen space divider jey side table yo side table uno lounge chair



screen space divider



auki coffee table **screen** space divider - free standing **uno** lounge chair



Sistema modulare di divisori con dimensioni e forme diverse. Telaio in metallo verniciato a polveri, tubolari in alluminio verniciato, rivestito in rovere sbiancato o nero poro aperto. Nella versione con rivestimento in tessuto l'imbottitura è in materiale isolante termoacustico in fibre poliestere termolegate e ignifughe. Sono disponibili piedini e giunti magnetici per l'unione degli elementi. SCREEN si abbina con sistema di sedute PLUS.

System of free standing screens with metal frame and tubes powder coated, or veneered in blanched oak, or oak black stained. Also available with a thermo-acoustic panel in fire-retardant polyester fiber upholstered with fabric. SCREEN can be linked with magnets and matched with PLUS seating system.

Modulares Trennwandsystem mit verschiedenen geformten Elementen in unterschiedlichen Größen. Der Rahmen ist aus pulverlackiertem Metall und kann mit Aluminiumröhren, pulverlackiert oder furniert in Eiche gebleicht oder schwarz offenporig gebeizt, kombiniert werden. Die stoffbezogene Version ist mit einem Kern aus feuerhemmenden Polyesterfasern versehen, die gleichzeitig isolierend und schallabsorbierend sind. Als Zubehör werden Metallfüße und Magnete zum Verbinden der Elemente angeboten. SCREEN eignet sich zur Kombination mit dem Sitzsystem PLUS.

Système de cloisons modulaires avec structure en metal laqué. Disponible avec tube revêtus en chêne blanchi, noir pore ouvert ou laqué ou en tissu posé sur un panneau thermo-acoustique en fibre polyester ignifugée qui absorbe le bruit. Les cloisons SCREEN peuvent être joints grâce à des aimants et combinées avec le système PLUS.

Sistema modular de divisores con diferentes dimensiones y formas. Estructura de metal lacada a polvo, tubular de aluminio lacado, revestido en roble blanqueado o negro poro abierto. En la versión revestida en tejido, el relleno está hecho de material que absorbe el sonido con fibras en poliéster unidas termicamente y resistentes al fuego. Disponible con pies o también con uniones magnéticas para unir los divisores. SCREEN se combina con el sistema de asientos PLUS.

 <p>Struttura <i>Verniciata a polvere:</i> nero bianco</p>	<p>Frame <i>Powder coated:</i> black white</p>	<p>Gestell <i>Pulverlackiert:</i> schwarz weiß</p>	<p>Structure <i>Laqué en poudre:</i> noir blanc</p>	<p>Estructura <i>Lacado en polvo:</i> negro blanco</p>
 <p>Tubolari rovere sbiancato nero poro aperto</p>	<p>Tubes blanched oak black open pore</p>	<p>Röhren Eiche gebleicht schwarz gebeizt offenporig</p>	<p>Tubes chêne blanchi noir pore ouvert</p>	<p>Tubular roble blanqueado negro poro abierto</p>
 <p>Verniciati a polvere: nero bianco</p>	<p>Powder coated: black white</p>	<p>Pulverlackiert: schwarz weiß</p>	<p>Laqué en poudre: noir blanc</p>	<p>Lacado en polvo: negro blanco</p>
 <p>Rivestimento tessuto</p>	<p>Upholstery fabric</p>	<p>Polsterung Stoff</p>	<p>Revêtement tissu</p>	<p>Revestido tejido</p>

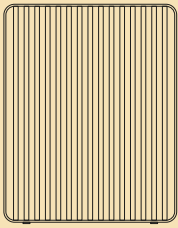

122
48"

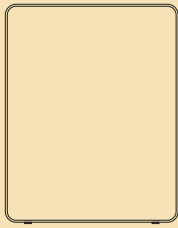

122
48"



161
63 1/2"

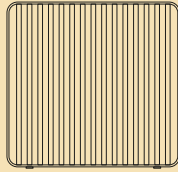

122
48"

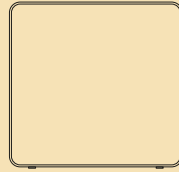

122
48"



121
47 1/2"

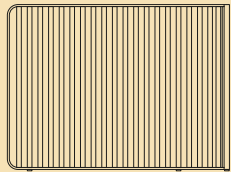

167
65 3/4"

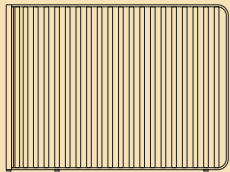

167
65 3/4"

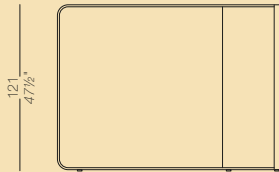

167
65 3/4"

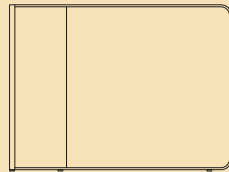

167
65 3/4"

121
47 1/2"

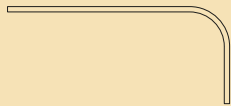

4
1 3/4"

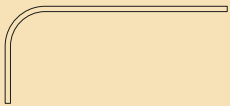

73
28 3/4"



4
1 3/4"

73
28 3/4"

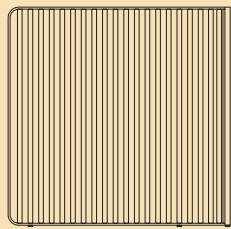

167
65 3/4"

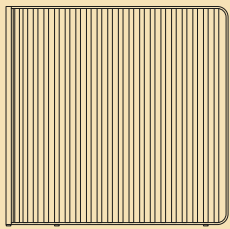

167
65 3/4"

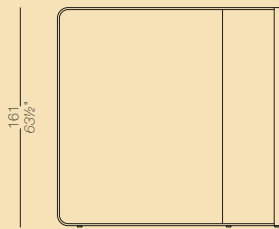

167
65 3/4"

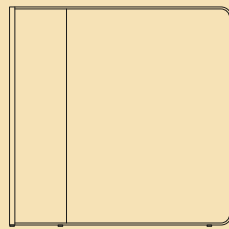

167
65 3/4"

161
63 1/2"

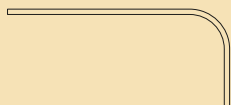

4
1 3/4"



73
28 3/4"



4
1 3/4"

73
28 3/4"

Accessories

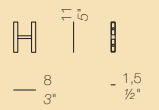

SCREEN

Sample configurations

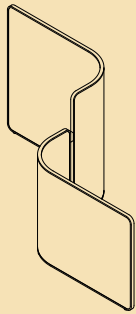

S – short

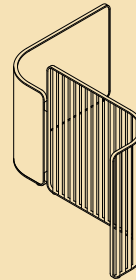

S – medium

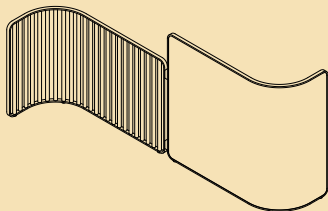

S – long

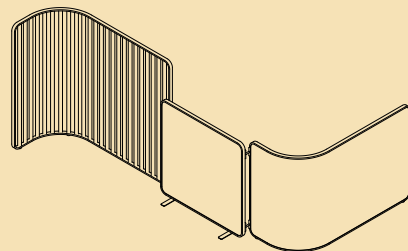

S – mixed

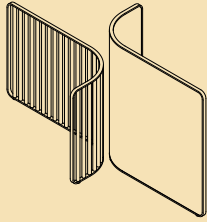

X_shape

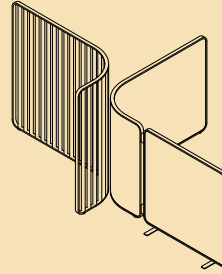

X_shape — big

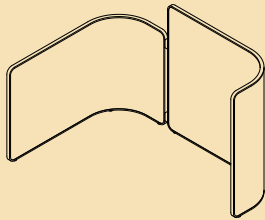

C — short

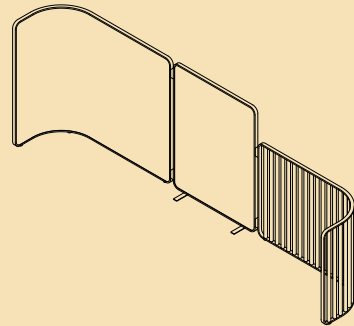

C — long

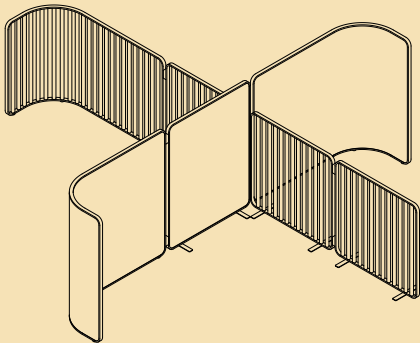

Intersections - 4

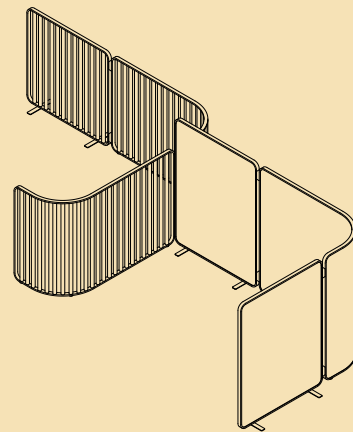

Intersections - 3

SCREEN

Sample configurations

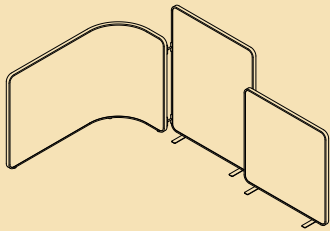

L_shape

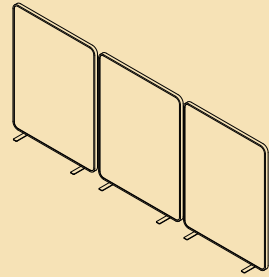

Wall shape

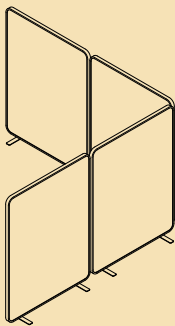

Corner shape

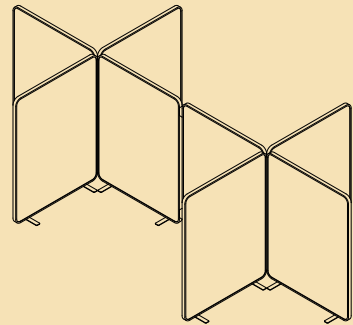

Cross shape

Passe-partout e versatile, il sistema di sedute UNO si declina in moltissime varianti, che si adattano perfettamente sia per la casa sia per il contract. Il sistema si basa su semplicità, ergonomia e comfort: due sedute si possono combinare con una varietà di schienali e di basi, a seconda delle scelte. Questo sistema forma un unico prodotto. UNO, appunto.

I colori dei tessuti di rivestimento sono contemporanei ed eleganti, secondo un'idea di arredo allo stesso tempo utile e dilettevole.

A versatile hybrid chair, the family of chairs UNO is available in several models perfectly adapting to residential or contract use. The system is based on simplicity, ergonomics and comfort: moulded seats can be matched with different backrests, depending on the function. This system takes just one product, UNO, and with contemporary and elegant palette of fabrics offers a useful and attractive lounge chair.

Vielseitig einsetzbar ist der Stuhl UNO ein echter Passe-Partout: er wird in so unterschiedlichen Varianten angeboten, dass er sich sowohl für den Wohn- als auch für den Objektbereich eignet. Schlichtheit, Ergonomie und Komfort zeichnen dieses Stuhlsystem aus: die Sitzfläche kann je nach Geschmack mit verschiedenen Rückenlehnen und Gestellen kombiniert werden. Dieses System verschmilzt zu einem Produkt: UNO. Die Farben der Bezugsstoffe sind modern und elegant, sodass die Einrichtung zweckmäßig und gleichzeitig ästhetisch ansprechend gestaltet werden kann.

Le système d'assises UNO permet une flexibilité dans l'usage: il peut s'adapter parfaitement soit à l'habitat soit à la collectivité. Le système se base sur les concepts de simplicité, d'ergonomie et de confort: deux types d'assises peuvent se combiner avec plusieurs bases et dossiers selon les besoins du client. Ce système crée un produit: d'où le nom UNO. Les tissus des revêtements sont contemporains et élégants pour créer un style d'ameublement utile et agréable en même temps.

Passe-partout y versátil, el sistema de asientos UNO disponible con muchas variaciones, encaja perfectamente para el hogar y también para el contrato. El sistema se basa en la simplicidad, la ergonomía y la comodidad: dos asientos que se pueden combinar con una variedad de respaldos y bases, según las opciones. Este sistema forma un solo producto. UNO, precisamente. Los colores de los tejidos del tapizado son contemporáneos e elegantes, de acuerdo con una idea de diseño útil y agradable.





uno lounge chair screen space divider



uno lounge chair oort cushion auki coffee table



uno lounge chair



uno lounge chair



uno lounge chair

auki coffee table screen space divider - free standing

plus pouf



kipu pouf

brio coffee table uno lounge chair

add s storage



Famiglia di sedute per diversi utilizzi, con basi fisse, regolabili in altezza su ruote (a 4 o 5 razze) e con sistema oscillante. Sedili e schienali in diversa altezza in poliuretano espanso ignifugo rivestito in tessuto, pelle o ecopelle.

Family of chairs also swivel with height adjustable base in aluminium, castors and tilt mechanism. Upholstered seat and backrest in several heights, fire retardant foam and fabric, leather or eco-leather.

Diese Stuhlfamilie eignet sich für unterschiedliche Einsatzbereiche und wird mit Gestellen in fixer Höhe, sowie höhenverstellbar und mit Rollen (4-oder 5 strahliger Fuß) angeboten. Sitz und Rückenlehne (in verschiedenen Höhen) sind aus feuerhemmendem Polyurethanschäum und können mit Stoff, Leder oder Kunstleder bezogen werden.

Famille de chaises, fixe ou avec hauteur réglable, roulette et fonction de bascule. Assise et dossier en différentes hauteurs en mousse ignifugée revêtue en tissu, peau ou éco-peau.

Familia de asientos para diversos usos, con bases fijas, regulables en altura sobre ruedas (4 o 5 piernas) y sistema oscilante. Asiento y respaldo en diferentes alturas en poliuretano ignifugo tapizado en tejido, cuero o ecopiel.

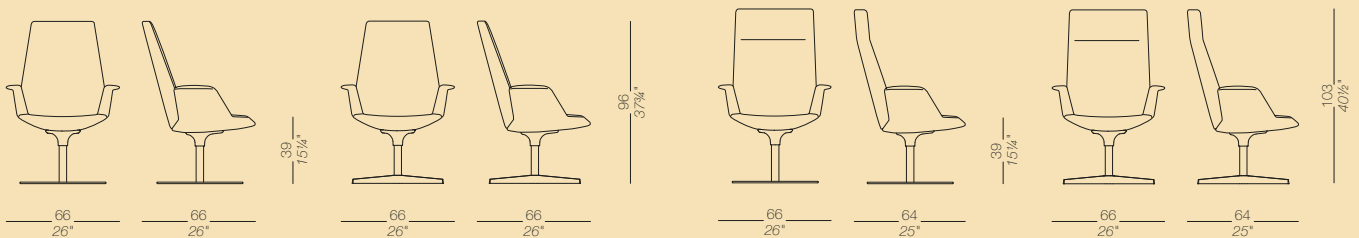

Struttura
inox
alluminio micropallinata



Verniciata a polvere:
nero
bianco



Rivestimento
tessuto



pelle
ecopelle



Frame
stainless steel
sandblasted aluminium

Powder coated:
black
white

Upholstery
fabric

soft-leather
ecoleather

Gestell
Edelstahl
Aluminium sandgestrahlt

Pulverlackiert:
schwarz
weiß

Polsterung
Stoff

Softleder
Kunstleder

Structure
inox
aluminium microbillé

Laqué en poudre:
noir
blanc

Revêtement
tissu

peau
peau synthétique

Estructura
acero inoxidable
aluminio arenado

lacado en polvo:
negro
blanco

Revestido
tejido

piel
ecopiel

Come ciottoli di fiume, una serie di pouff di forma triangolare arrotondata e angoli smussati, dalla memoria quasi primordiale: KIPU è un elemento di arredo multiuso – ottomano, seduta, appoggio, tavolino – adatto per ogni tipo di ambiente ma sicuramente ideale nelle aree lounge, che acquistano un tocco informale, dinamico, quasi domestico. Tre dimensioni e tre altezze diverse, oltre alle declinazioni in brillanti toni di colore, ne ampliano con versatilità le possibilità di arredo. Da comporre liberamente come un arcipelago.

Like pebbles, a family of ottomans with a rounded triangular shape and a primordial memory, KIPU is a crossover piece of furniture - ottoman, seat, low table – suitable for every place and for sure ideal in a lounge area, which get an informal, dynamic almost residential touch. Three dimensions and three heights with many shades of colors offer a variety of possibilities to combine like a group of islands.

An Flusskiesel erinnern diese Polsterhocker mit ihrer dreieckigen Form und den abgerundeten Ecken: KIPU ist ein multifunktionaler Einrichtungsgegenstand – Fußhocker, Sitzgelegenheit, Ablagefläche oder Tischchen – und passt in jede Umgebung. Aber sicherlich ist er ideal für Loungezonen, die dadurch eine ungezwungene, dynamische und beinahe wohnliche Atmosphäre bekommen. Die drei verschiedenen Größen und Höhen, sowie die reiche Auswahl an leuchtenden Farben, machen diesen Hocker vielseitig einsetzbar: es können damit wahre Inselgruppen gestaltet werden.

De forme triangulaire arrondie comme les cailloux d'un fleuve, d'une mémoire primordiale, KIPU est un système d'assises modulables. C'est un ensemble crossover – pouf, assise, table basse – qui s'adapte à chaque espace, particulièrement idéal dans un lounge qui devient informel, dynamique presque domestique. Trois dimensions et trois hauteurs, plusieurs déclinaisons de couleurs élargissent les possibilités d'aménagement des espaces pour composer en toute liberté comme un archipel.

Como piedras de río, una serie de puf de formas triangulares redondeadas y angulos biselados, de la memoria primordial: KIPU es una pieza multifuncional de mobiliario - puf, asiento, apoyo- mesa, adecuado para cualquier tipo de ambiente, pero sin duda perfecto para las zonas lounge, dan un toque informal, dinámico, casi hogareño. Tres tamaños y tres alturas diferentes, además de las variaciones en los tonos de color, amplían con versatilidad las posibilidades de decoraciones; para componer libremente como un archipiélago.





kipu pouf



kipu pouf oort cushion



kipu pouf add coffee table auki lounge chair auki coffee table





kipu pouf jey side table



kipu pouf jey side table



kipu pouf



Pouf con imbottitura in schiumato di poliuretano con fibra poliester accoppiata ignifughi, rivestito in tessuto, pelle o ecopelle, completamente sfoderabile. Piedini in polietilene e feltro.

Ottoman with fire-retardant moulded polyurethane foam and polyester fiber with removable fabric, leather or eco-leather. Feet in polyethylene with felt.

Polsterhocker aus feuerhemmendem Polyurethan-Polyesterschaum mit abziehbarem Bezug aus Stoff, Leder oder Kunstleder, Gleiter aus Polyethylen mit Filzeinsatz.

Pouf avec rembourrage en mousse de polyuréthane et polyester ignifugée. Revêtement déhoussable en tissu, peau ou ecopeau. Pieds en polythène et feutre.

Puf con acolchado en espuma de poliuretano y fibra de poliéster a prueba de fuego, tapizados en tejido, piel o eco-piel, completamente extraíble. Pies de polietileno y fieltro.

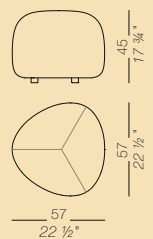
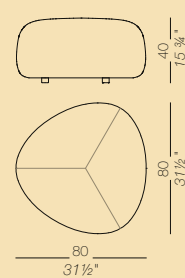
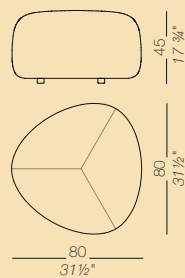
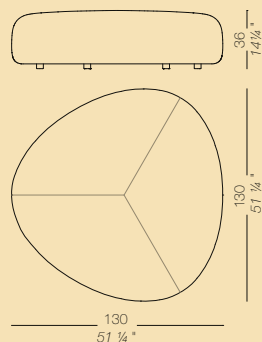
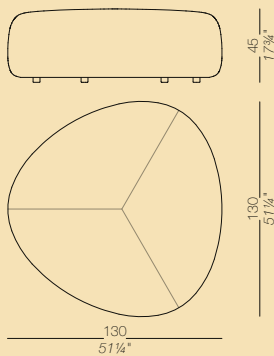

Rivestimento
tessuto



pelle
ecopelle

Upholstery
fabric

soft-leather
ecoleather

Polsterung
stoff

softleder
kunstleder

Revêtement
tissu

peau
peau synthétique

Revestido
tejido

piel
ecopiel

Morbidezza, si può. E si può immaginare un ufficio che accolga una seduta ampia e generosa. Altri tempi di incontro, o semplicemente più tempo, come a casa. Nel segno del relax, il sistema di sedute ADD SOFT aggiunge profondità e si apre alla più felice ars combinatoria. Nelle dimensioni avvolgenti, la gamba del telaio si riduce in altezza per dare spazio al comfort dei cuscini. Completano la funzionalità del divano i piani di appoggio con prese elettriche. Ed è un peccato doversi alzare.

Softness is possible. And you can imagine an office that accommodates wide and spacious seating. Time for meetings or simply more time, as at home. In the name of relaxation, the ADD SOFT seating system adds depth and opens up to the most successful art of combinations. With its embracing dimensions, the legs of the frame are reduced in height to make space for comfortable cushions. The tabletops with electric sockets complement the functionality of the sofa. And it is a pity to get up from it.

Weichheit ist möglich. Denn man kann sich durchaus ein Büro vorstellen, das mit einer breiten und großzügigen Sitzgelegenheit ausgestattet ist. Für andere Zeiten des Zusammentreffens oder einfach mehr Zeit, so wie zu Hause. Im Zeichen der Entspannung zeichnet sich das Sitzmöbelsystem ADD SOFT durch Tiefe aus und ist offen für die geglückteste ars combinatoria. Durch seine bequemen Auslegung wird das Bein des Rahmens in der Höhe reduziert, um dem Komfort der Kissen Raum zu bieten. Die Ablageflächen mit Steckdosen vervollkommen die Zweckmäßigkeit des Sofas. Es ist einfach zu schade, wieder aufstehen zu müssen.

Oui à la douceur. On peut imaginer un bureau qui s'adapte à une assise grande et généreuse. Pour d'autres moments de rencontre, ou simplement plus de temps, comme à la maison. Au nom de la détente, le système d'assises ADD SOFT ajoute de la profondeur et s'ouvre aux arts combinatoires (ars combinatoria) les plus heureux. Dans les grandes dimensions, le piètement du cadre est réduit en hauteur pour donner de l'espace au confort des coussins. Le canapé est complété par des surfaces d'appui avec prises électriques. Quel dommage de devoir se lever.

Suavidad, se puede. Y se puede imaginar una oficina que acoja un asiento amplio y generoso. Otros momentos de encuentro, o simplemente más tiempo, como en casa. Marcado por el relax, el sistema de asientos ADD SOFT añade profundidad y se abre a la más feliz ars combinatoria. En las dimensiones envolventes, la pata de la estructura reduce su altura para dar espacio a la comodidad de los cojines. Completan la funcionalidad del sofá las superficies de apoyo con tomas eléctricas. Es una lástima tener que levantarse.

ADD SOFT

Francesco Rota | 2018





add soft three seater low — open yo side table



add soft three seater low — open





add soft vis-à-vis yo side table kipu pouf



add soft vis-à-vis _2 jey side table

ADD SOFT

Francesco Rota | 2018

Sistema di sedute modulari, con telaio di base in alluminio estruso e cinghie elastiche incrociate, con fori perimetrali per fissare schienali e braccioli in posizioni diverse. Gambe angolari e centrali in pressofusione di alluminio. Cuscini e schienali sfoderabili in poliuretano a densità differenziata, rivestiti in tessuto. Possibilità di piano d'appoggio in varie finiture anche con prese elettriche. Parti metalliche verniciate a polveri.

Modular seating system with powder coated die-cast aluminium frame and webbed elastic support. Backrests and accessories can be fixed to the frame in several positions by using existing holes. Die-cast aluminium legs, one for corners and another to connect frames for larger configurations. Cushions and backrest in fire-retardant polyurethane foam with different density, upholstered with removable fabric. ADD is complemented by tops in various finishes, also with sockets. All metal parts are powder coated.

Modulares Sitzsystem mit Gestell aus Aluminiumprofilen und elastischen Riehmern. Bohrungen im Rahmen ermöglichen die Befestigung von Rücken- und Armlehnen an verschiedenen Stellen. Die Beine sind aus Aluminiumdruckguss. Sitzkissen und Rückenlehnen aus Polyurethanschaum mit abziehbarem Stoffbezug. Es besteht auch die Möglichkeit Tischplatten in verschiedenen Ausführungen, auf Wunsch auch mit integrierter Steckdose, zu montieren. Die Metallkomponenten sind pulverlackiert.

Système polyvalent d'assises et dossiers modulaires, avec structure en aluminium laqué et sangles élastiques. Grâce aux percements périmétraux, les dossiers et les accoudoirs peuvent être fixés en différentes positions. Pieds en fusion d'aluminium. Coussins et dossiers en mousse ignifugée en polyuréthane de différentes densités revêtus de tissu. Plateaux disponibles en plusieurs finitions avec aussi prise électriques. Parties en métal laquées en poudres.

Sistema de asiento modular con estructura de aluminio extruso lacado a polvo y correas elásticas entrelazadas. El respaldo y los accesorios se pueden fijar a la estructura en varias posiciones utilizando puntos de fijación pre perforados. Piernas de aluminio fundido, una para esquinas y otra de unión para conectar configuraciones más grandes. Cojines y respaldo de espuma ignífuga de poliuretano con diferentes densidades, tapizados con tejido desenfundables. ADD se complementa con encimeras en varios acabados también con enchufes. Todas las partes de metal están lacadas a polvo.

	Struttura <i>Verniciata a polvere:</i> nero bianco	Frame <i>Powder coated:</i> black white	Gestell <i>Pulverlackiert:</i> schwarz weiß	Structure <i>Laqué en poudre:</i> noir blanc	Estructura <i>Lacado en polvo:</i> negro blanco
	Rivestimento tessuto	Upholstery fabric	Polsterung Stoff	Revêtement tissu	Revestido tejido
	pelle ecopelle	soft-leather ecoleather	Softleder Kunstleder	peau peau synthétique	piel ecopiel
	Piano laminato Fenix® 0,9 nero laminato Fenix® 0,9 bianco	Top laminato Fenix® 0,9 black laminato Fenix® 0,9 white	Platte Laminat Fenix® 0,9 schwarz Laminat Fenix® 0,9 weiß	Plateau lamifié Fenix® 0,9 noir lamifié Fenix® 0,9 blanc	Encimera laminado Fenix® 0,9 negro laminado Fenix® 0,9 blanco
	rovere sbiancato nero poro aperto	blanched oak black open pore	Eiche gebleicht schwarz gebeizt offenporig	chêne blanchi noir pore ouvert	roble blanqueado negro poro abierto

Lounge seat frames

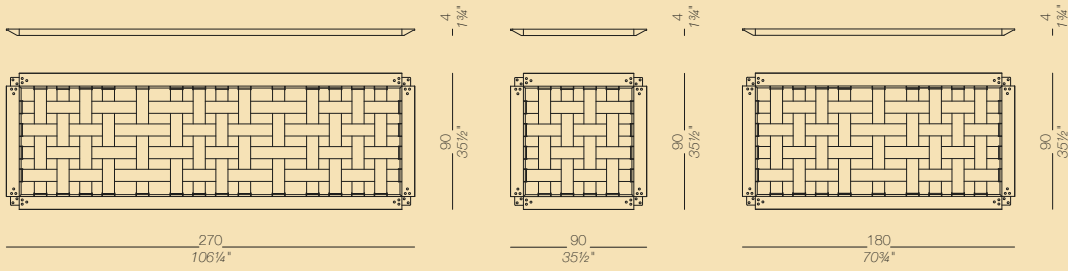

Lounge seats

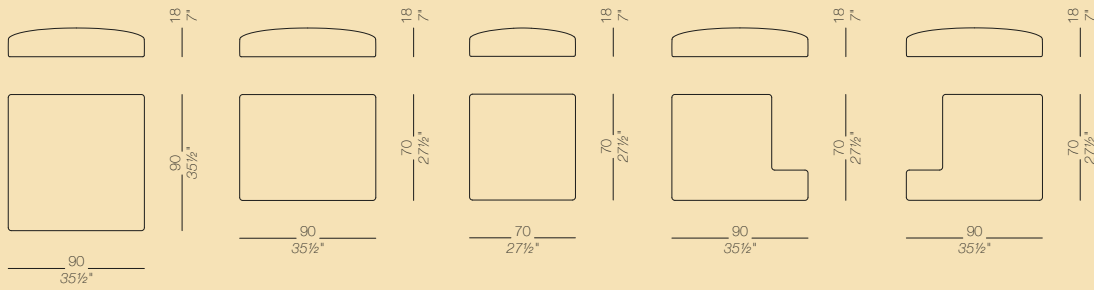
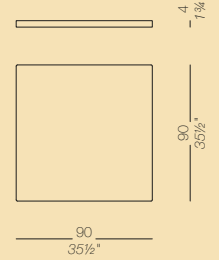
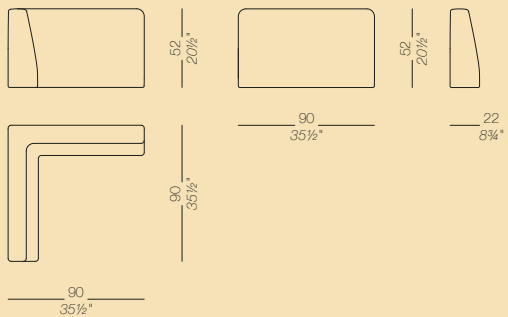

Table Top



Lounge backs



Armrest

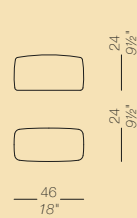

Legs



ADD SOFT

Sample configurations

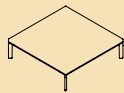

Coffee Table

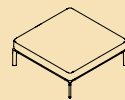

Pouf

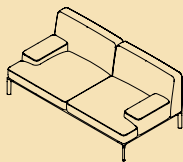

Two seater — low

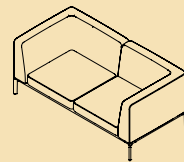

Two seater — high

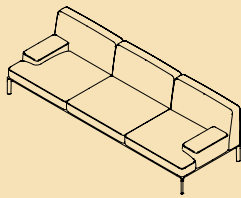

Three seater — low

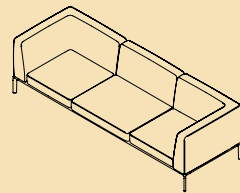

Three seater — high

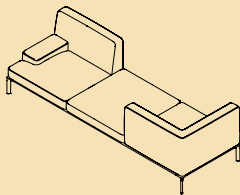

Vis-à-vis

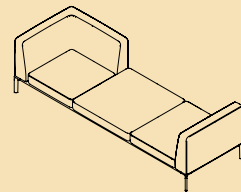

Vis-à-vis - 2

ADD SOFT

Sample configurations

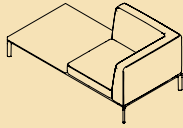

One seater high + table

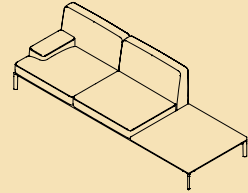

Two seater low + table

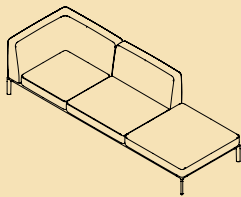

Three seater high — open

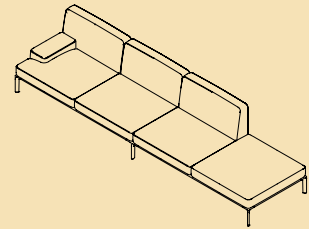

Side by side — open

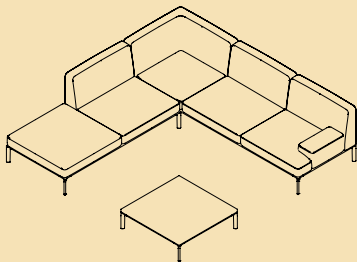

L_shape small — open

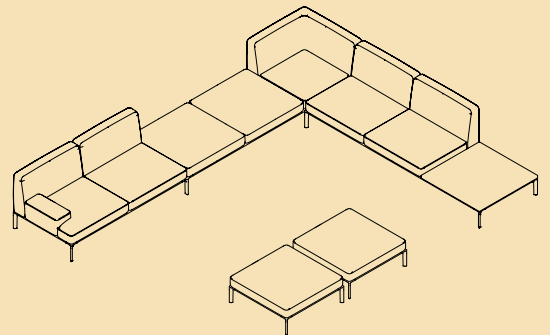

L_shape big — open

Poltroncina imbottita, dal profilo ondulato e compatto. Design fluido e linee snelle, ergonomia e grande comfort, PASS ha un volume avvolgente reso però più leggero dalla struttura su cui poggia e per questo si può utilizzare in ogni ambiente, casa o ufficio, anche grazie alla varietà di colori e finiture della collezione. Per questo risulta essere un elemento perfetto per arredare le zone lounge, intese come luoghi di condivisione e spazi di attesa contemporanei.

Upholstered chair with compact and curved outline. With a fluid design and light shapes, ergonomic and good comfort level, PASS has an embracing volume made lighter by its base; it is suitable both for home and office thanks to the variety of colours in the range. It is a perfect element also for lounge areas and contemporary waiting rooms.

Gepolsterter Sessel, kompaktes, geschwungenes Profil. Fließendes Design und klare Linien, Ergonomie und Komfort. PASS hat ein umhüllendes Volumen, wirkt aber durch die Struktur, auf der er ruht, optisch leichter. Auf diese Weise kann man Pass in jedem Raum, zu Hause oder im Büro verwenden, nicht zuletzt dank der Vielfalt von Farben und Oberflächen der Kollektion. Dadurch eignet sich PASS perfekt für moderne Loungebereiche, unter denen wir Wartezonen oder einfach gemeinschaftlich genutzte Räume verstehen.

Petit fauteuil rembourré au profil ondulé et compact: son design fluide et la finesse de ses lignes, son volume moulant posé légèrement sur différents piétements, une large gamme de tissus et de coloris, donnent au PASS une simplicité essentielle et un confort qui permet de l'utiliser aussi bien à la maison qu'au bureau et qui le rend parfait pour les espaces lounge conçus comme des lieux de partage contemporains.

Butaca acolchada, de perfil ondulado y compacto. Diseño fluido con líneas esbeltas, ergonomía y gran confort; PASS nace con un volumen envolvente que gana levedad en la estructura que la sostiene. La variedad de colores y acabados de la colección la hacen ideal para vestir cualquier ambiente de la casa o la oficina. Por esto resulta ser un elemento perfecto para decorar salas lounge, diseñados como lugares de intercambio y espacios de espera contemporáneos.





pass lounge chair



pass lounge chair brio coffee table



pass lounge chair **brio** table **plus** S_shape – big



pass lounge chair **add t** table **screen** space divider



brio coffee table **pass** lounge chair



PASS

brio coffee table **pass** lounge chair



brio coffee table **pass** lounge chair



Poltroncina imbottita in schiumato di poliuretano ignifugo rivestito in tessuto, pelle o eco-pelle anche con abbinamento di 2 colori (abbinamento possibile previo il consenso dell'azienda). Disponibile con base a slitta, in metallo cromo satinato o verniciata a polveri. Basi in alluminio girevoli, anche su ruote o regolabili in altezza micropallinate o verniciate.

Chair with fire-retardant moulded foam upholstered with fabric, leather or ecoleather, also in two colours (matching of fabrics to be approved). Sled base mat chromed or powder coated. Also available with height adjustable swivel seat and castors on die cast base, powder coated or sand-blasted.

Kleiner Sessel aus feuerhemmendem Polyurethanschaum mit Bezug aus Stoff, Leder oder Kunstleder. Auch zweifarbige Stoffkombinationen sind möglich, müssen jedoch mit laplama abgestimmt werden. Erhältlich mit verschiedenen Gestellen: Schlittengestell, pulverlackiert oder matt verchromt, oder Gestell aus Aluminiumdruckguss, sandgestrahlt oder pulverlackiert, drehbar und höhenverstellbar. Auch mit Rollen verfügbar.

Petit fauteuil en mousse de polyuréthane ignifugée revêtue de tissus, peau ou ecopeau avec possibilité de combinaison de deux couleurs (contacter l'usine pour approbation). Piètement luge chromé mat ou laqué, base centrale pivotante en fusion d'aluminium laquée ou sablée, ou réglable en hauteur sur roulettes.

Sillón, con espuma resistente al fuego, tapizado en tejido, piel o eco-piel: se pueden combinar dos colores (contactar con la fábrica para su aprobación). Disponible con base trineo, en metal cromado mate o lacada a polvo. Bases giratorias en aluminio, también a ruedas o regulables en altura, lacada a polvo o cromado mate.

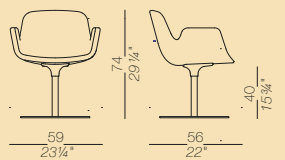
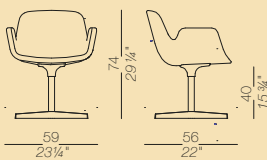

Struttura
cromo satinato



Verniciata a polvere:
nero
bianco



Rivestimento
tessuto



pelle
ecopelle

Frame
mat chromed

Powder coated:
black
white

Seating
fabric

soft-leather
ecoleather

Gestell
matt verchromt

Pulverlackiert:
schwarz
weiß

Sitzfläche
Stoff

Softleder
Kunstleder

Structure
chromé mat

Laqué en poudre:
noir
blanc

Assise
tissu

peau
peau synthétique

Estructura
cromado mate

lacado en polvo:
negro
blanco

Asiento
tejido

piel
ecopiel

È un tavolino perfetto per il vivere quotidiano: adatto quindi a lavorare o rilassarsi, sia in casa sia in uno spazio lounge o una sala d'aspetto. La gamba – disegnata a forma di Y, che dà il nome al prodotto – è decentrata rispetto al piano e permette a YO di avvicinarsi a chi è seduto, offrendo un confortevole piano di appoggio. Le diverse altezze a cui è possibile regolare il piano, fanno sì che si trasformi da supporto per laptop a tavolino per snack e relax.

This perfect side table for daily living whether working with a laptop or relaxing, both at home, a lounge area or a waiting room. Its foot, being Y shaped provides a cantilever and with the height adjustment, the table can be easily accessed when sitting at various heights.

Dieser Beistelltisch eignet sich bestens für den alltäglichen Gebrauch: zum Arbeiten oder Entspannen, zu Hause, in Loungezonen oder Warteräumen. Das Gestell nimmt die Form eines "Y" auf - daher auch der Name des Produkts - und ist dezentriert an der Tischplatte angebracht. Dadurch lässt sich das Tischchen nah an jede Sitzgelegenheit heranschieben und kann bequem genutzt werden. Die Tischplatte ist höhenverstellbar und so kann der Tisch zum Schreiben mit dem Laptop oder als Ablagefläche für Snacks genutzt werden, wenn man sich nach der Arbeit entspannen möchte.

Une petite table parfaite pour le quotidien: pour travailler ou se relaxer, à la maison, dans un espace lounge ou dans une salle d'attente. Le pied - en forme de Y qui donne le nom au produit - est décentré par rapport au plateau et permet son utilisation devant un canapé. De hauteur réglable, YO est un support idéal pour travailler sur son ordinateur, pour déjeuner sur le pouce, ou comme table d'appoint.

Es una mesita perfecta para la vida cotidiana: es adecuada para el trabajo o para el ocio, ya sea en el hogar o en la sala de espera. La pata en forma de Y, que le da el nombre al producto, se descentraliza a la encimera y permite que la mesita YO se acerque a los que están sentados ofreciendo un cómodo plano de apoyo. Las diferentes alturas regulables de la mesa hacen que se convierta en un apoyo ideal para un portátil, mesita para bocadillos y el relax.





yo side table auki lounge chair

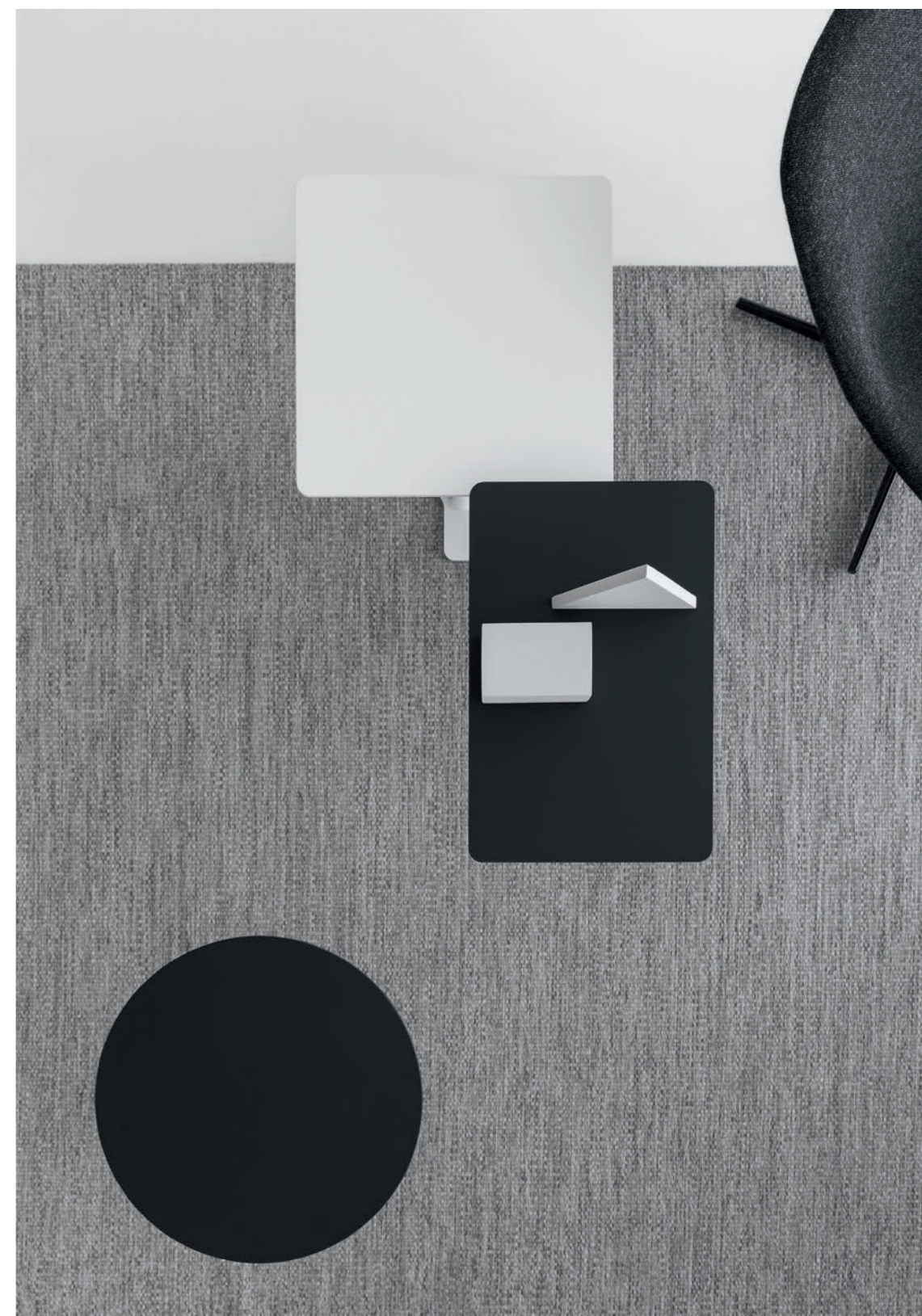

yo side table auki lounge chair



yo side table



yo side table plus classic medium auki lounge chair



kipu pouf yo side table plus pouf



Tavolino regolabile in altezza con base e colonna in metallo verniciato a polveri. Il piano anti-rotazione, è disponibile in diverse finiture e forme.

Side table with height adjustable top in several finishes. Metal base and column powder coated.

Höhenverstellbarer Beistelltisch mit Gestell aus pulverlackiertem Metall. Die Tischplatte ist in verschiedenen Formen und Ausführungen erhältlich.

Petite table réglable en hauteur avec base et colonne laqués en poudre. Le plateau est disponible en plusieurs finitions.

Mesa regulable en altura con base y columna en metal lacado a polvo. La encimera con sistema antirotación está disponible en diferentes acabados y formas.

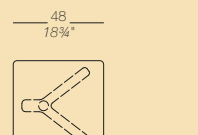
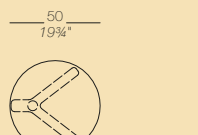
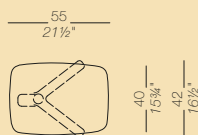
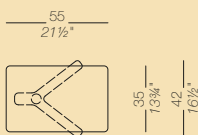
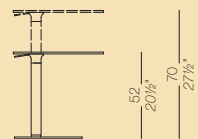
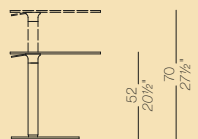
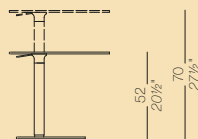
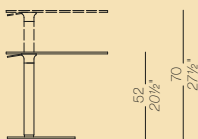

Struttura
verniciata a polveri:
nero
bianco

Frame
Powder coated:
black
white

Gestell
Pulverlackiert:
schwarz
weiß

Structure
Laqué en poudre:
noir
blanc

Estructura
Lacado en polvo:
negro
blanco

Piano
HPL Fenix® nero
HPL Fenix® bianco

Top
HPL Fenix® black
HPL Fenix® white

Platte
HPL Fenix® schwarz
HPL Fenix® weiß

Plateau
HPL Fenix® noir
HPL Fenix® blanc

Encimera
HPL Fenix® negro
HPL Fenix® blanco

 rovere sbiancato
nero poro aperto
rovere noce scuro

blanched oak
black open pore
oak stained dark-walnut

Eiche gebleicht
schwarz gebeizt offenporig
Eiche dunkel nussbaum gebeizt

chêne blanchi
noir pore ouvert
chêne teinté wengé

roble blanqueado
negro poro abierto
roble nogal oscuro

Versatile e flessibile, ADD è il protagonista dell'area lounge. Che sia per un ristorante, un museo, un aeroporto o una sala d'attesa, il sistema ADD è sintesi perfetta di un innovativo modo di concepire la seduta componibile, completa di tavolini con diverse misure e accessori per sostenere tablet e notebook. In un mosaico di innumerevoli combinazioni, ADD permette un gioco costruttivo che può allungarsi a piacere, combinarsi fronte-retro, ad S, a cerchio, adattandosi agli elementi architettonici esistenti. Il sistema – dotato di imbottitura e rivestito in stoffa – si declina in una gamma di colori e tessuti adatti ad ogni ambiente.

Versatile and flexible, ADD is the protagonist in the lounge area. Both in a restaurant, a museum, an airport or a waiting room, the modular system ADD is the perfect synthesis of an innovative way to define the modular seating, including small tops at different heights and cases for tablets. With a variety of possible combinations, ADD offers a constructive play that can be extended to snake-shaped configuration or circles or simply by adapting it to existing architecture. The system, upholstered with fire-retardant foam and fabric or leather, is available in a large choice of colours that can fit in every space.

Vielseitig und wandelbar, ist ADD der Hauptdarsteller im Bereich Lounge. Ob für ein Restaurant, ein Museum oder einen Flughafen, ADD bereichert jeden Warteraum und steht für eine neue und innovative Art und Weise modulare Sitzmöbel zu entwerfen. Tischchen in verschiedenen Höhen und Zubehör wie Tablet- oder PC-Halter ergänzen das System. ADD bietet unzählige Kombinationsmöglichkeiten: die einzelnen Elemente können spielerisch zu endlos langen, s- oder kreisförmigen Kompositionen zusammengefügt werden, die sich so perfekt an die jeweiligen architektonischen Gegebenheiten anpassen. Die Bezüge für die weich gepolsterten Kissen können aus einer breiten Palette an Stoffen und Farben ausgewählt werden.

Polyvalent et flexible, ADD est le protagoniste de l'espace lounge. Que ce soit dans un restaurant, un musée, un aéroport ou une salle d'attente, le système ADD est la synthèse parfaite d'une façon innovante de décliner les assises modulaires, enrichies de tables basses et porte-tablette. Dans une mosaïque de plusieurs combinaisons, ADD permet un jeu constructif qui peut être prolongé grâce à des configurations rondes, sinueuses ou simplement en s'adaptant aux éléments architectoniques existants. Le système, rembourré et revêtu de plusieurs matériaux, peut se décliner en de nombreuses couleurs qui s'adaptent aux différents espaces.

Versátil y flexible, ADD es el protagonista de la sala de estar. Podría tratarse de un restaurante, un museo, un aeropuerto o una sala de espera. El sistema ADD es la síntesis perfecta de una forma innovadora de concebir el sofa modular, con mesas de diferentes alturas y accesorios para sostener el tablet y portátiles. En un mosaico de infinitas combinaciones, ADD permite un juego constructivo que puede ser compuesto a voluntad. Combinaciones para ambos lados del sofa, en forma de S, circunferencias, adaptándose a los elementos arquitectónicos existentes. El sistema – con acolchado y tapizado en tejido – tiene una amplia gama de colores y tipos de tejidos que se adaptan a cualquier entorno.





add square bench + high table



add V_shape out auki lounge chair auki coffee table add V_shape in



ADD





add round out + tablet supports + high tunable tables

brio coffee table

kipu pouf



add round out + tablet supports + high tunable tables kipu pouf brio coffee table

THE MODERN EYE

architecture & design

exhibition presents

architectural projects on five continents that respond to localized needs in communities. These innovative designs signal a renewed sense of community by many of today's practitioners, to the social responsibilities of the past. Though the stance echoes socially engaged movements of the past, what is highlighted here are not interested in grand manifestos or utopian theories, their commitment to a radical pragmatism can be seen in the projects realized, from a handmade school in Bangladesh to a reconsideration of a housing project in Paris, from an apartheid museum in South Africa to a project that connects a single hillside barrio in Caracas to the city at large. These projects offer an exciting shift in the longstanding dialogue between architecture and society, which the architect's methods and approaches are being dramatically re-evaluated. They also propose an expanded definition of sustainability that moves beyond environmentalism with new materials and technologies to include such considerations as social and economic stewardship.

← entrada exhibit entry

biglietti tickets

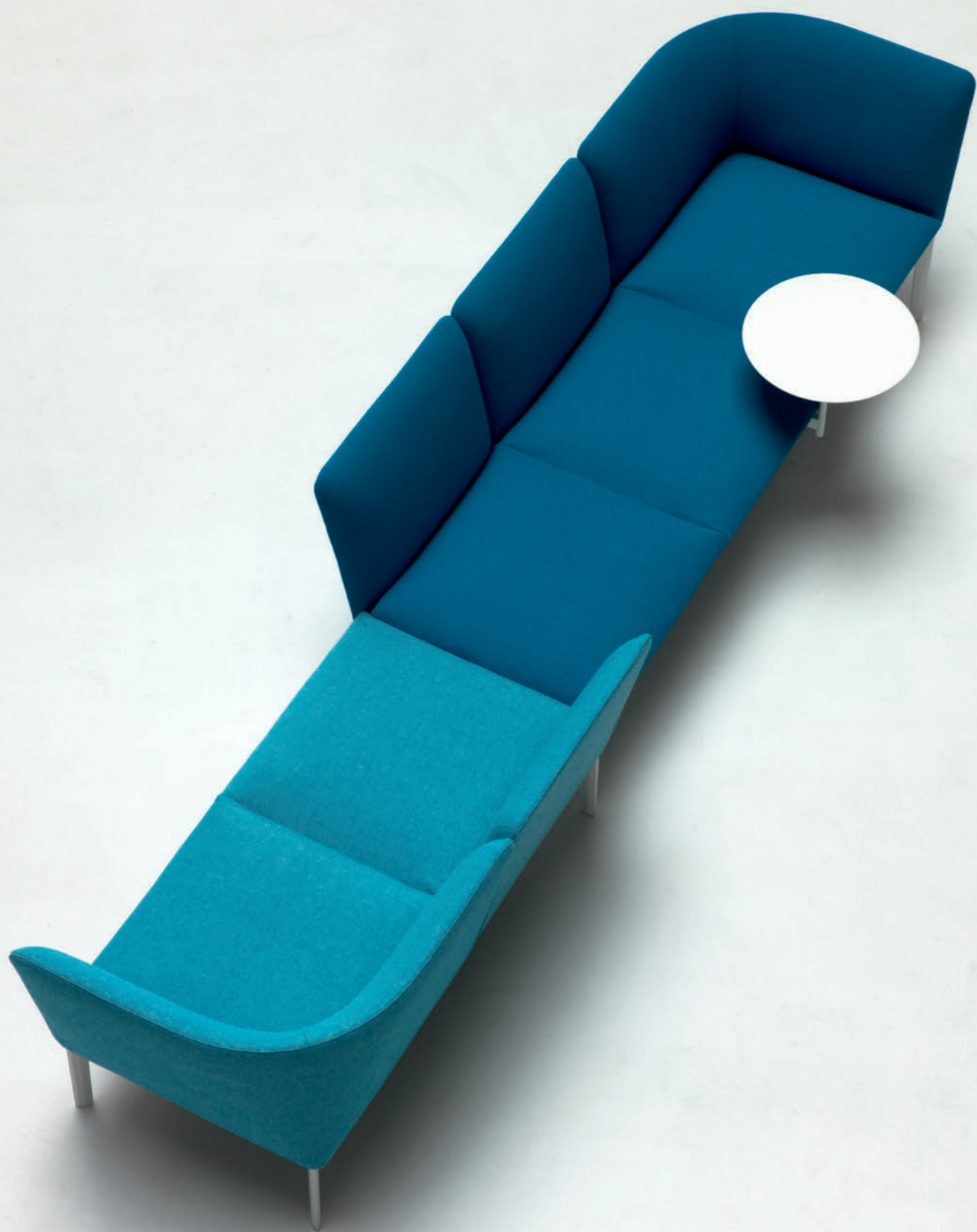

add vis-à-vis – big + high table



add vis-à-vis – big + high table





auki lounge chair **add** vis-à-vis – small **brio** coffee table



add S_shape + turnable table + magazine unit + tray

ADD



add bench



Sistema di sedute modulari, con telaio di base in alluminio estruso e cinghie elastiche incrociate, con fori perimetrali per fissare schienali e accessori in posizioni diverse. Gambe in due altezze angolari o centrali in pressofusione di alluminio. Cuscini e schienali sfoderabili in schiumato di poliuretano con fibra poliestere accoppiata ignifughi, rivestiti in tessuto, pelle ed ecopelle. Vari accessori in laminato HPL Fenix® da mm. 10 completano il sistema: piani di appoggio, vassoio, portariviste, contenitore per prese elettriche e porta tablet girevole 90° in alluminio anodizzato colore nero. Parti metalliche verniciate a polveri.

Modular seating system with powder coated aluminium frame and elastic belts, with holes where backrest and accessories can be fixed. Legs in die cast aluminium in two heights. Cushions and backrest in fire-retardant moulded polyurethane foam and polyester fiber with removable fabric, leather or eco-leather. Accessories in HPL Fenix® mm.10: tables, trays, box for sockets and revolving (90°) case box for tablet.

Modulares Sitzsystem mit Gestell aus Aluminiumprofilen und elastischen Riemen. Bohrungen im Rahmen ermöglichen die Befestigung von Rückenlehnen und Zubehör an verschiedenen Stellen. Endfüße und Verbindungsfüße aus Aluminiumdruckguss in zwei verschiedenen Höhen und Kissen aus feuerhemmendem Polyurethan-Polyesterschaum mit abziehbarem Bezug aus Stoff, Leder oder Kunstleder sind verfügbar. Verschiedenes Zubehör aus HPL Fenix® mit Stärke 10 mm vervollständigt das System: Tischplatten, Behälter, Zeitschriftenfach sowie ein drehbarer Tablethalter aus schwarzem Aluminium. Die Metallkomponenten sind pulverlackiert.

Système polyvalent d'assises et dossiers modulaires, avec structure en aluminium laqué et sangles élastiques. Grâce aux percements périmétraux, les dossiers et les accessoires peuvent être fixés en différentes positions. Pieds en fusion d'aluminium proposés en deux hauteurs différentes. Coussins et dossiers en mousse de polyurethane et fibres de polyester ignifugées, revêtues de tissu, peau ou ecopelle. Accessoires en HPL Fenix® 10 mm.: tops, plateaux pour magazines et prises électriques et porte-tablette pivotant (90°) en aluminium anodisé laqué noir.

Sistema modular de asientos, con estructura en aluminio extruido y cintas elásticas cruzadas, con agujeros perimetrales para la fijación del respaldo y accesorios en diferentes posiciones. Patas en dos alturas, angulares o centrales de aluminio fundido inyectado a presión. Cojines y respaldos en espuma de poliuretano y fibras de poliéster a prueba de fuego, tapizados extraíbles en tejido, piel y eco-piel. Varios accesorios en laminado HPL Fenix® mm. 10 completan el sistema: encimeras, bandejas, revisteros, contenedores para tomas de corriente eléctrica y soporte para tablet giratoria (90°) en aluminio anodizado lacado negro.

Lounge seat frames

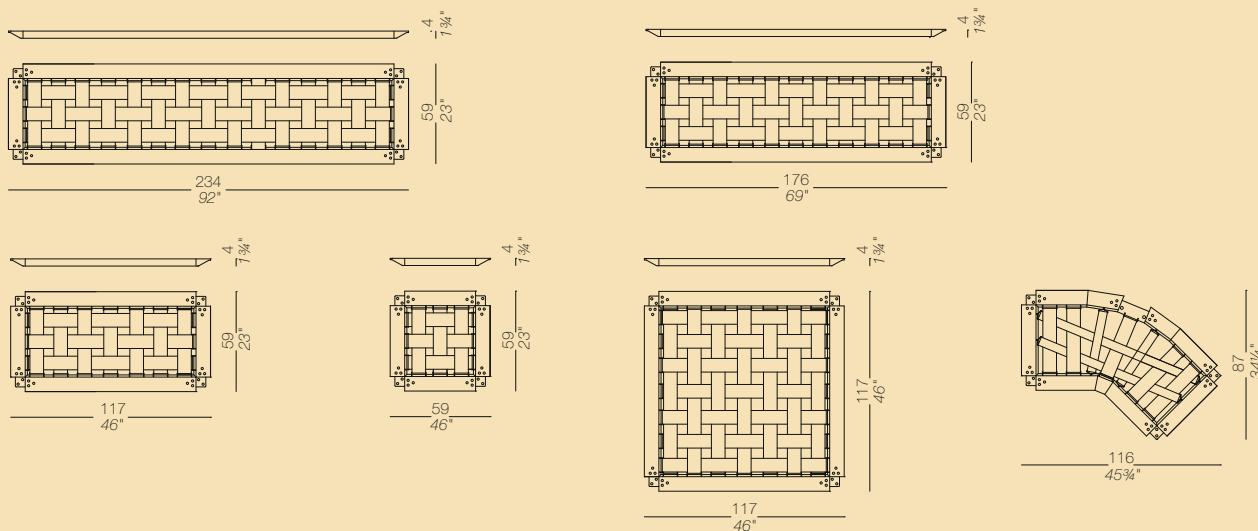

Lounge seats

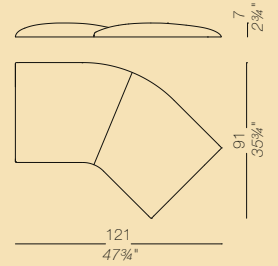
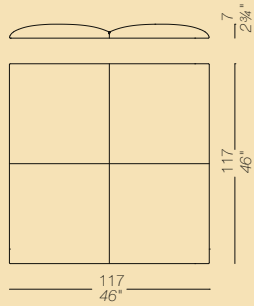
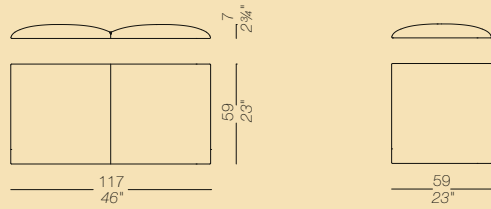
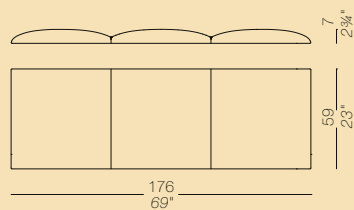
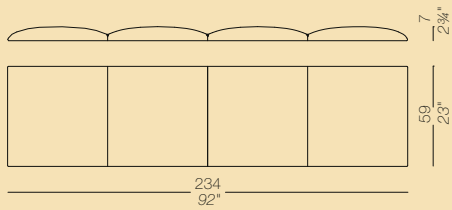

Lounge backs

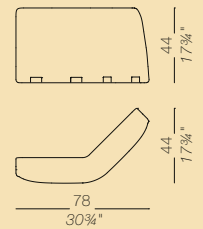
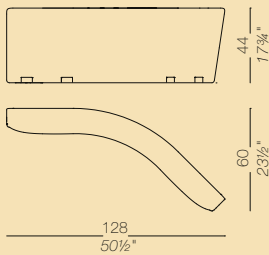
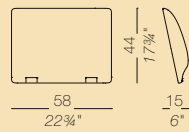
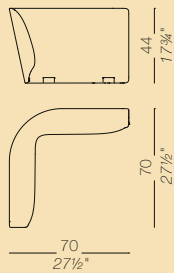

Table frames

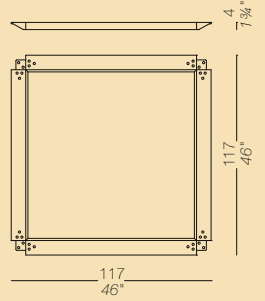
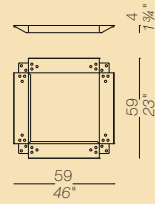
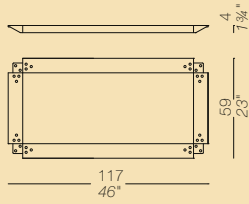
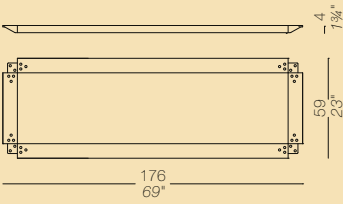
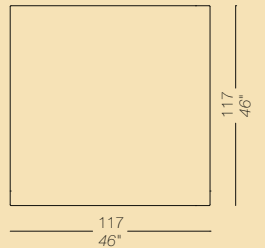
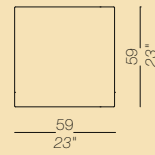
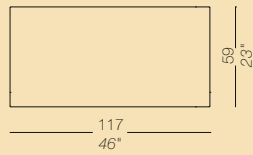
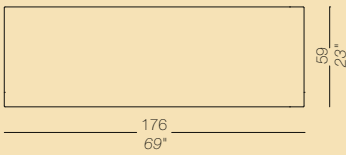
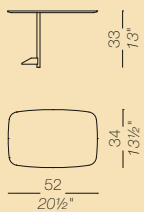

Table tops



High tables



Legs



High legs



Tablet support

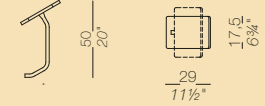

Charging tray unit

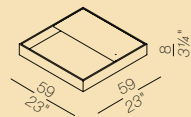

Tray

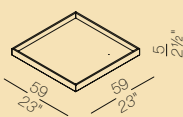

Magazine unit

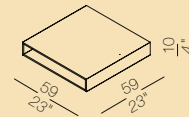

Low tables

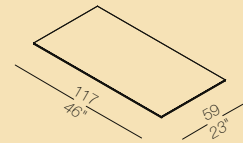
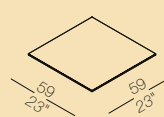

Struttura
Verniciata a polvere:
nero
bianco

Frame
Powder coated:
black
white

Gestell
Pulverlackiert:
schwarz
weiß

Structure
Laqué en poudre:
noir
blanc

Estructura
Lacado en polvo:
negro
blanco

Rivestimento
tessuto

Upholstery
fabric

Polsterung
Stoff

Revêtement
tissu

Revestido
tejido

pelle
ecopelle

soft-leather
ecoleather

Softleder
Kunstleder

peau
peau synthétique

piel
ecopiel

Piano
HPL Fenix® nero
HPL Fenix® bianco

Top
HPL Fenix® black
HPL Fenix® white

Platte
HPL Fenix® schwarz
HPL Fenix® weiß

Plateau
HPL Fenix® noir
HPL Fenix® blanc

Encimera
HPL Fenix® negro
HPL Fenix® blanco

ADD

Sample configurations



One seater

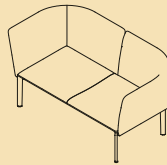

Two seater

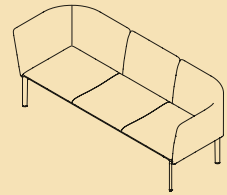

Three seater

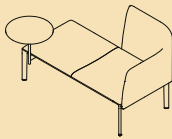

Classic mini

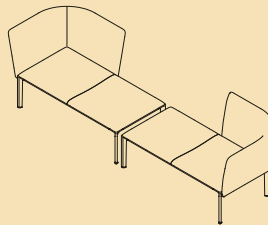

Classic mini — double

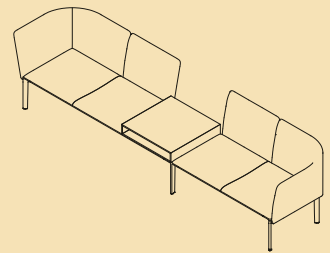

Side by side

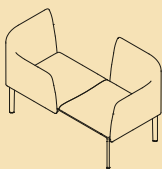

Vis-à-vis — small

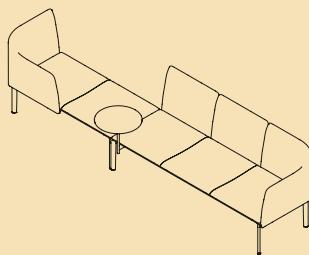

Vis-à-vis — big

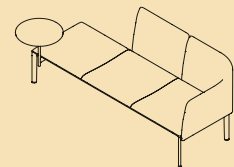

Classic

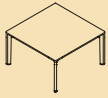

Stool

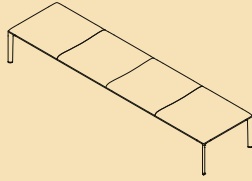

Bench

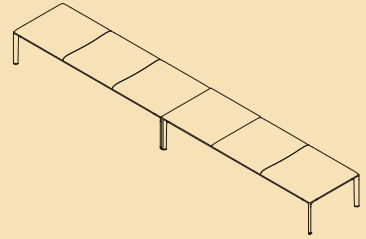

Long bench

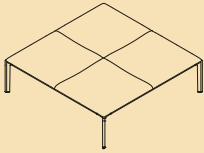

Square bench

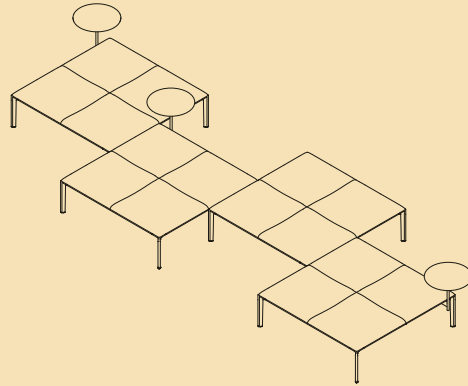

Square bench system

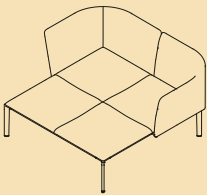

Lounge

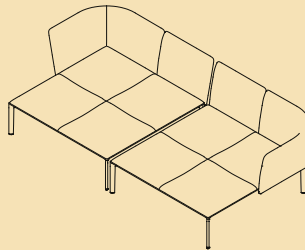

Lounge — double

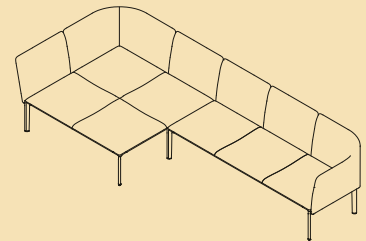

Sofa

ADD

Sample configurations

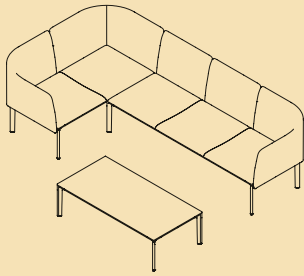

L_shape

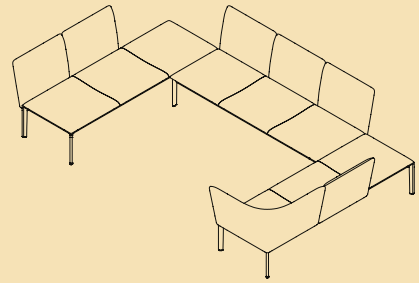

C_shape

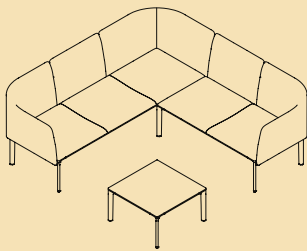

L_shape — big

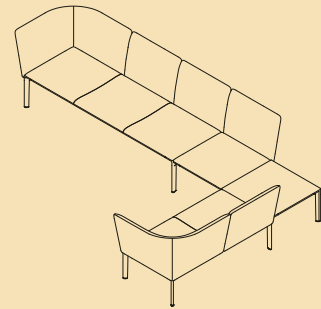

L_shape — open

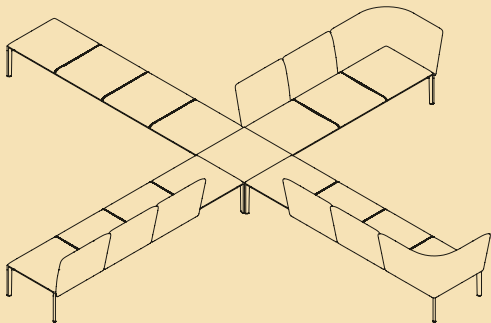

X_shape

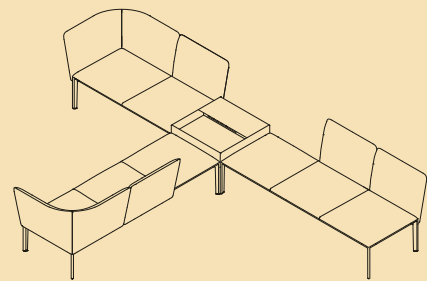

T_shape

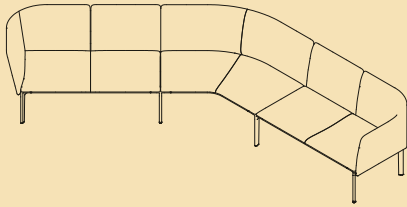

V_shape in

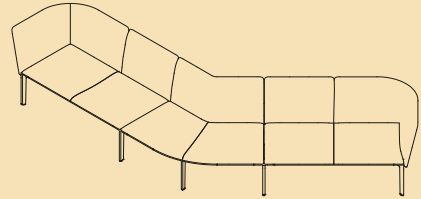

V_shape out

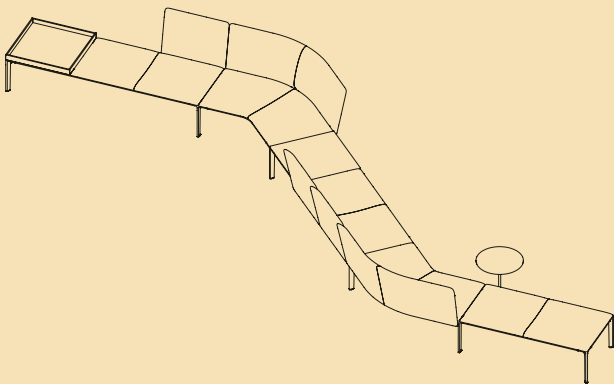

S_shape

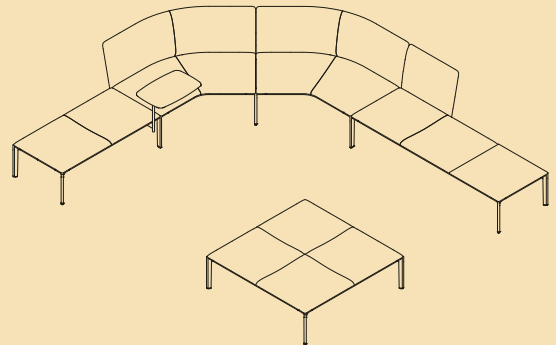

Big lounge

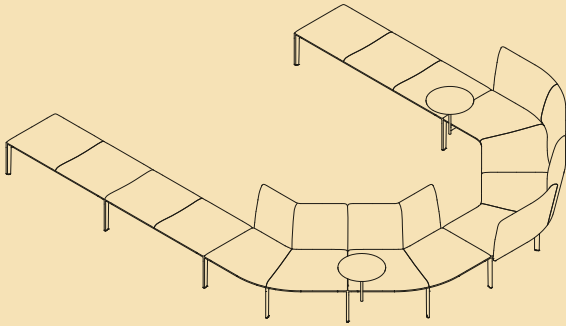

U_shape

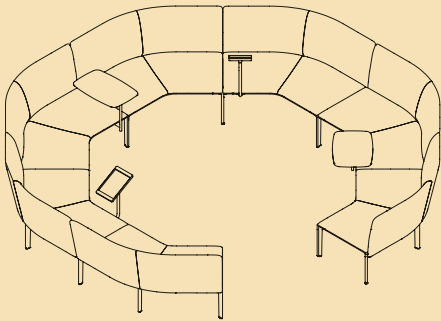

Round in

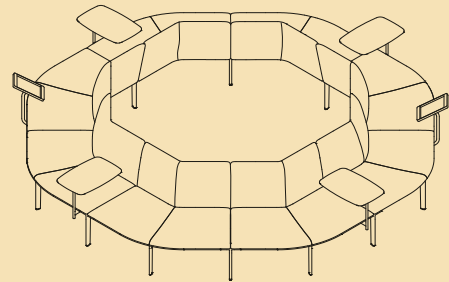

Round out

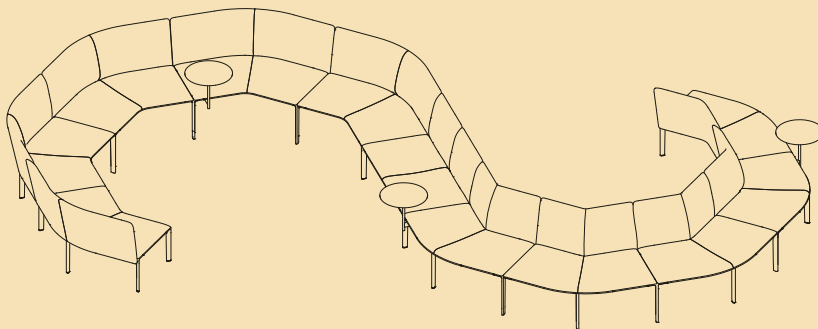

S_shape – big

ADD

Sample configurations

Coffee tables

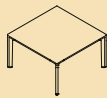

One

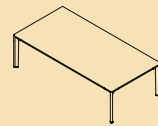

Two

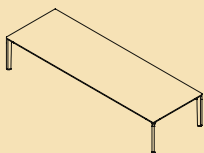

Three

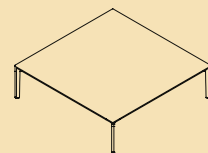

Four

Non solo un tavolino. Ma un elemento d'arredo scultoreo e versatile. Contemporaneo, multifunzionale e mutevole, ha una caratteristica unica: una maniglia che lo rende agevolmente trasportabile e abbinabile, sovrapponendo due altezze diverse e alternando i due colori, bianco e nero in diverse composizioni. La base in marmo o cemento lo ancora a terra, mentre il piano presenta insolite forme geometriche arrotondate.

Not just a side table but a piece of furniture which is both versatile and sculptural. Contemporary, multifunctional with a unique characteristic: a quirky handle that also makes it easy to carry. The various top shapes, black and white finishes and different table heights allow the users to overlap the JEY when used in numbers to give interesting configurations. However playful, the JEY is stable with its base in concrete or marble.

Nicht nur ein Beistelltisch. Sondern Skulptur und vielseitiger Einrichtungsgegenstand in einem. Modern, multifunktional und wandelbar, besitzt der Tisch eine Besonderheit: durch den Griff lässt sich der Tisch leicht anheben und verschieben; die Kombinationsmöglichkeiten sind durch die zwei verschiedenen Höhen und die Farben schwarz und weiß beinahe unbegrenzt. Die Tischplatte mit ihren ungewöhnlichen geometrischen Formen ruht auf einem Marmor- oder Betonzylinder.

Petite table mais aussi objet d'art, sculpture multifonction et contemporaine avec une caractéristique principale: la poignée qui permet de la déplacer facilement et la combiner avec d'autres tables de hauteur différente. Tops blanc ou noir de formes géométriques arrondies.

No es solo una mesita. Es un elemento de mobiliario escultural y versátil. Contemporáneo, multifuncional y mudable, tiene una característica única: una manija que facilita de mover y combinar, sobreponiendo dos alturas diferentes y alternando los dos colores, blanco y negro en diferentes composiciones. La base de mármol o cemento lo ancla al suelo, mientras que la encimera tiene formas geométricas redondeadas.





jeY side table plus pouf



jeY side table plus pouf





jev side table auki coffee table kipu pouf



jev side table add round in



jeu side table



Tavolino con base in marmo Bianco Carrara, Nero Marquinia o cemento. Piani in laminato HPL Fenix® bianco o nero di forme diverse, con relative parti metalliche verniciate a polveri. Disponibile in due altezze con o senza maniglia.

Occasional table with marmor base white Carrara, black Marquinia or concrete. Top in hpl Fenix® white or black in several shapes and powder coated metal stem. Available in two heights with or without handle.

Beistelltisch mit Basis aus Carrara- bzw. Marquinia-Marmor oder Beton. Tischplatte mit unterschiedlichen Formen in HPL Fenix weiß oder schwarz, Metallkomponenten pulverlackiert. Verfügbar in zwei verschiedenen Höhen, mit oder ohne Griff.

Petite table avec base en marbre blanc Carrara, noir Marquinia ou beton. Top en hpl Fenix® blanc ou noir avec formes différentes et parties métalliques laquées. Disponible en deux hauteurs sans ou avec la poignée.

Mesita con base en mármol blanco de Carrara, Marquinia negra o cemento. Encimeras en HPL Fenix® blanca o negra de diferentes formas, w las partes metálicas lacadas a polvo. Disponible en dos alturas con o sin manija.

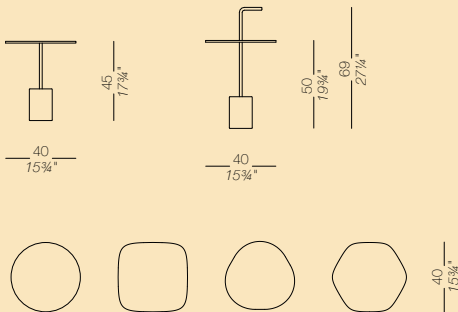

Base
 cemento

Base
 concrete

Basis
 Beton

Base
 béton

Base
 cemento



Bianco Carrara
 Nero Marquinia

white Carrara
 black Marquinia

Carrara-Marmor weiß
 Marquinia-Marmor schwarz

blanc Carrara
 noir Marquinia

blanco Carrara
 negro Marquinia



Struttura
verniciata a polvere:
 nero
 bianco

Frame
Powder coated:
 black
 white

Gestell
Pulverlackiert:
 schwarz
 weiß

Structure
Laqué en poudre:
 noir
 blanc

Estructura
Lacado en polvo:
 negro
 blanco



Piano
 HPL Fenix® nero
 HPL Fenix® bianco

Top
 HPL Fenix® black
 HPL Fenix® white

Platte
 HPL Fenix® schwarz
 HPL Fenix® weiß

Plateau
 HPL Fenix® noir
 HPL Fenix® blanc

Encimera
 HPL Fenix® negro
 HPL Fenix® blanco

Cuscino dalla geometria morbida ma strutturata, OORT si adatta come perfetto complemento per le sedute e i divani, da sempre caratterizzati da linee contemporanee, geometriche e minimali. Realizzato in una fibra speciale che permette al cuscino di tornare alla condizione iniziale, OORT si presenta con una forma rettangolare, quadrata, o come cuscino di supporto per lombare. Grazie alle molteplici declinazioni cromatiche dei tessuti, con OORT si possono creare giochi di contrasto, tono su tono, o gradazioni più morbide e sfumate, a seconda delle scelte estetiche.

A cushion with soft and well-structured geometry, OORT is a perfect complement to chairs and sofas with contemporary and minimalistic lines. OORT is made of a special filling which readily reverts to its original shape, either rectangular or square and offers good back support. Thanks to the chromatic choice, with OORT it is possible to create contrasts by playing with shades and colour hues based on aesthetic choices.

Ein weiches Kissen mit klaren Formen: OORT passt perfekt zu den Sofas und Sitzmöbeln mit ihren klaren, einfachen und modernen Linien. OORT wird aus einem besonderen Fasermaterial hergestellt, damit das Kissen immer wieder in seine ursprüngliche Form zurückkehrt. Angeboten werden rechteckige oder quadratische sowie Nierenkissen. Durch die Farbvielfalt, in der sich OORT herstellen lässt, kann man mit Kontrasten spielen, Ton-in-Ton-Kombinationen herstellen oder abgestufte Nuancen wählen.

Le coussin OORT avec sa forme souple est un complément qui s'adapte parfaitement aux assises et canapés toujours caractérisés par des lignes contemporaines, géométriques et minimales. OORT est produit par une fibre spéciale qui lui permet de rester gonflé après usage.

Cojín con formas geométricas suaves pero estructurado, OORT es un complemento perfecto para asientos y sofás, siempre caracterizado por líneas contemporáneas, geométricas y minimalistas. Hecho de una fibra especial que permite que la almohada vuelva a su forma original, OORT tiene una forma rectangular, cuadrada o como cojín de soporte lumbar. Gracias a las varias opciones de color de los tejidos, con OORT se pueden crear contrastes, tonos iguales o gradaciones suaves y matizadas, según a la elección estética de cada uno.





oort cushion plus classic



oort cushion add big lounge auki coffee table



oort cushion uno lounge chair



oort cushion plus L_shape 5



oort cushion add vis-à-vis



Cuscini in tessuto sfoderabili di varie misure, con imbottitura composta da una miscela di microfibre poliestere, ipoallergeniche e idrorepellenti.

Cushions in microfiber of hypoallergenic polyester with removable fabric in several dimensions.

Kissen mit abziehbarem Bezug in verschiedenen Größen, Füllung aus Polyester-Mikrofaser, hypoallergen und wasserabweisend.

Coussins amovibles en plusieurs dimensions, rembourrés en microfibras de polyester hypoallergénique. Disponibles dans les tissus de la collection.

Almohadas en tejido extraíble de varios tamaños, con relleno compuesto por una mezcla de microfibras de poliéster, hipoalergénicas y repelentes al agua.

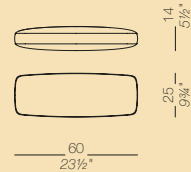
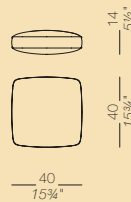
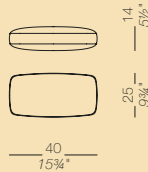
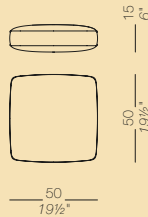
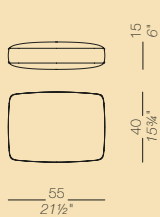

Rivestimento
tessuto

Upholstery
fabric

Polsterung
Stoff

Revêtement
tissu

Revestido
tejido

Una superficie elegantemente sinuosa, che asseconda il corpo nella seduta, è alla base dell'idea di questa poltroncina dalla linearità essenziale e pulita. La leggera curvatura crea un bracciolo appena accennato.

Il modello base di AUKI si arricchisce di un poggiatesta e un ottomano che lo trasformano quasi in una chaise-longue estremamente confortevole. La famiglia AUKI si diversifica con tipi di gambe diverse e si allarga a due tipologie di tavolino (rotondo e quadrato, con superfici in laminato, HPL Fenix® o legno) che rendono le composizioni adatte agli spazi lounge.

An elegant curved surface that follows the body is the basic idea of this lounge chair with an essential and clean line. The gentle contour outlines the armrests and the headrest and foot-rest make it almost a chaise-longue extremely comfortable. AUKI family is enriched by different legs and low tables (round or square with top in HPL Fenix® or wood) which make it perfect for the lounge area.

Eine elegant geschwungene Fläche, die den Körper stützt, ist die Idee hinter diesem Sessel mit den klaren, sauberen Linien. Die leichte Rundung des Sitzes erzeugt eine kleine Armlehne. Das Basismodell AUKI kann mit einer Kopfstütze oder einer Fußstütze ausgestattet werden und so wird daraus beinahe eine komfortable Chaiselongue. Die „Familie“ AUKI differenziert sich durch verschiedene Gestellformen. Zwei Tischchen (rund oder quadratisch mit Platte aus HPL Fenix® oder Holz) ergänzen das Programm und so eignet sich AUKI hervorragend für Loungebereiche.

Une surface élégante et sinueuse forme une assise qui suit le corps: c'est la base de l'idée de cette chaise longue essentielle et rigoureuse dont la silhouette légère dessine les accoudoirs. La chaise peut avoir un appuie-tête et un repose-pieds qui la transforme en une chaise longue extrêmement confortable. La famille AUKI est disponible avec différents pieds et deux tables basses rondes ou carrées (avec top en HPL Fenix® ou bois) pour mieux compléter les solutions lounge.

Una superficie de elegancia sinuosa, que acompaña el cuerpo en el asiento, la idea base de esta silla es la linealidad esencial y limpia. Una ligera curva de los bordes, crea un reposabrazos poco acentuado. El modelo básico del sillón AUKI, se enriquece con un apoyo para la cabeza y un reposa pies que transforman el AUKI en un sillón muy cómodo. La familia AUKI se diferencia con diferentes tipos de piernas y se amplía con dos tipos de mesas (redonda y cuadrada, con superficies laminadas, Fenix® o madera) que hacen composiciones adecuadas para salas lounge.



← Gates A1-A16



auki lounge chair

auki coffee table

add square bench

brio table



auki lounge chair auki coffee table



auki lounge chair auki coffee table



kipu pouf

auki lounge chair auki coffee table



auki coffee table kipu pouf



kipu pouf auki coffee table



auki lounge chair

auki coffee table



auki lounge chair **auki** ottoman **auki** coffee table

Poltrona con imbottitura in schiumato di poliuretano ignifugo rivestita in tessuto, pelle o ecopelle. Disponibile con base in legno di frassino verniciato o 4 gambe in metallo, base girevole a stella, o su disco verniciato a polveri o in cromo satinato. Disponibile anche con poggiatesta

Poggiapiedi con imbottitura in schiumato di poliuretano ignifugo rivestito in tessuto, pelle o ecopelle. Base in metallo a stella verniciata o cromo satinata o con gambe in legno verniciate. Tavolo con base in metallo verniciata a polveri o in cromo satinato. Piani in diverse misure e finiture.

Lounge chair in fire-retardant moulded polyurethane foam upholstered with fabric, leather or ecoleather. Four legged base in metal or ash, swivel 4-star base or metal plate powder coated or mat chrome. Self levelling glides with felt. Headrest also available.

Footstool with moulded fire-retardant foam upholstered in fabric, leather or ecoleather. Four star metal base powder coated or mat chromed or with wooden legs. Coffee table with metal base powder coated or mat chromed. Tops in several dimensions and finishes.

Loungesessel aus feuerhemmendem Polyurethanschaum bezogen mit Stoff, Leder oder Kunstleder. Verfügbar mit vier Beinen aus Holz oder Metall, Zentralsäule mit Kreuzfuß oder runder Bodenplatte, pulverlackiert oder matt verchromt. Auch mit Kopfstütze erhältlich.

Ebenfalls verfügbar ist ein Fußhocker aus feuerhemmendem Polyurethanschaum mit Bezug aus Stoff, Leder oder Kunstleder und Kreuzfuß aus pulverlackiertem Metall oder vier Beinen aus Holz. Ein Tischchen mit Gestell aus pulverlackiertem oder matt verchromtem Metall ergänzt das Programm. Tischplatte in verschiedenen Größen und Ausführungen erhältlich.

Chaise lounge en mousse de polyuréthane ignifugée et revêtue de tissus, peau ou ecopeau. Disponible avec pieds en frêne ou en métal avec patins sur vérons en plastique et feutre, ou base pivotante ronde ou en croix, laquée ou chromée mat. Disponible aussi avec appuie-tête.

Repose-pieds en mousse ignifugée revêtue de tissus, peau ou ecopeau. Base en metal laqué ou chromé mat ou en bois. Table basse avec base en métal laqué ou chromé mat et top en plusieurs dimensions et finitions.

Sillón acolchado en espuma de poliuretano a prueba de fuego, tapizado en tejido, piel o eco-piel. Disponible con base de 4 patas en fresno o metal lacado, base giratoria 4-estrella o redonda, lacadas a polvo o en cromado satinado. También disponible con reposacabezas.

Reposapiés acolchado en espuma de poliuretano a prueba de fuego tapizado en tejido, piel o eco-piel. Base en metal a estrella lacada o cromado mate o con patas de madera. Mesa con base en metal lacada a polvo o cromado mate. Encimeras de diferentes tamaños y acabados.

Seats

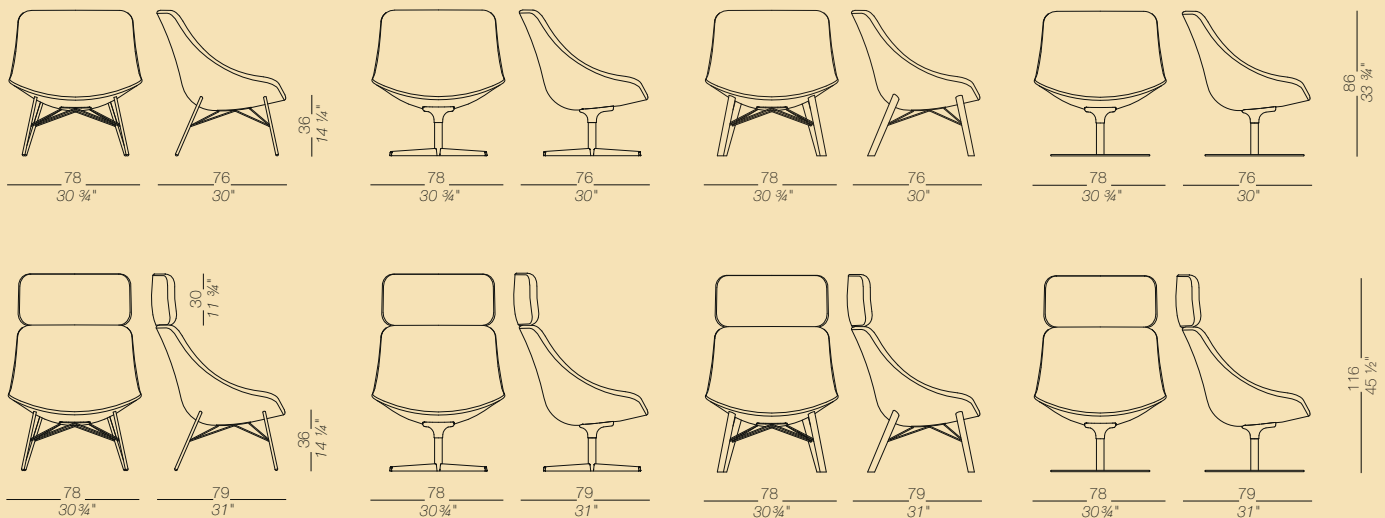







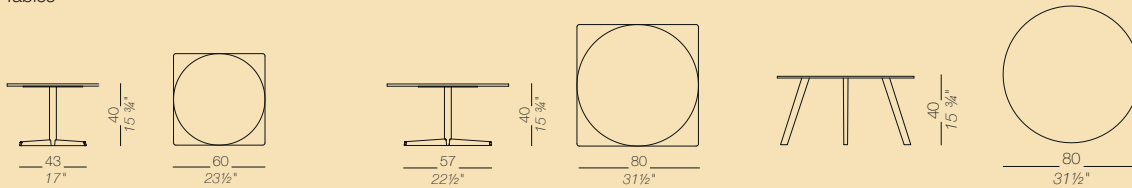



Ottomans



Tables



	Struttura cromo satinato		Frame mat chromed		Gestell matt verchromt		Structure chromé mat		Estructura cromado mate
	<i>Verniciata a polvere:</i> nero		<i>Powder coated:</i> black		<i>Pulverlackiert:</i> schwarz		<i>Laqué en poudre:</i> noir		<i>Lacado en polvo:</i> negro
	frassino naturale nero poro aperto		natural ash black open pore		Esche natur schwarz gebeizt offenporig		frêne naturel noir pore ouvert		fresno natural negro poro abierto
	Rivestimento tessuto		Upholstery fabric		Polsterung Stoff		Revêtement tissu		Revestido tejido
	pele ecopelle		soft-leather ecoleather		Softleder Kunstleder		peau peau synthétique		piel ecopiel
	Piano laminato bianco HPL bianco HPL rovere sbiancato HPL Fenix® nero HPL Fenix® bianco		Top white laminate white HPL blanched oak HPL black Fenix® HPL white Fenix® HPL		Platte Laminat weiß HPL weiß HPL Eiche gebleicht HPL Fenix® schwarz HPL Fenix® weiß		Plateau lamifié blanc HPL blanc HPL chêne blanchi HPL Fenix® noir HPL Fenix® blanc		Encimera laminado blanco HPL blanco HPL roble blanqueado HPL Fenix® negro HPL Fenix® blanco
	rovere sbiancato		blanched oak		Eiche gebleicht		chêne blanchi		roble blanqueado
	rovere noce scuro		oak stained dark-walnut		Eiche dunkel nussbaum		chêne teinté wengé		roble nogal oscuro
	nero poro aperto		black open pore		schwarz gebeizt offenporig		noir pore ouvert		negro poro abierto
	laccato bianco		white lacquered		weiß lackiert		laqué blanc		lacado blanco

BRIO è un tavolo leggero e versatile, perfetto per bar e ristoranti, ma può essere facilmente prestato ad altri ambiti: in ufficio o a casa si trasforma in un piano d'appoggio extra, estensione della scrivania o di supporto al divano. Il piano, rotondo o quadrato in diverse essenze, ha molteplici dimensioni e altezze regolabili, per una massima flessibilità.

A light versatile table that is perfect for bars and restaurants, but that can be easily adapted for use in other contexts, e.g. at the office, in the home to provide extra work space, as an extension to a desk or in tandem with a sofa. Table tops are round or square in various wood types, come in various dimensions and are height adjustable to ensure maximum flexibility.

BRIO ist ein leichter und vielseitig einsetzbarer Tisch, ideal für Bars und Restaurants. Er kann ebenso auch in anderen Bereichen eingesetzt werden: im Büro oder zu Hause verwandelt er sich in eine zusätzliche Ablagefläche, die Erweiterung des Schreibtischs oder in einen Couchtisch. Die runde oder eckige Tischplatte gibt es in verschiedenen Ausführungen und Größen. Die Höhenverstellbarkeit verleiht eine maximale Flexibilität.

BRIO est une table légère et polyvalente, parfaite pour bars et restaurants, mais facilement adaptable à d'autres endroits: au bureau ou à la maison elle se transforme en plan de travail supplémentaire, en bureau d'appoint ou bout de canapé. Le plateau, rond ou carré, est proposé en différents bois, plusieurs dimensions et avec hauteur réglable, pour offrir le maximum de flexibilité.

BRIO es una mesa ligera y versátil, perfecta para bares y restaurantes, pero que se presta a ser acogida fácilmente en otros espacios: en la oficina o en la casa se transforma en un plano de apoyo extra, una extensión del escritorio, o un complemento para el sofá. El plano, redondo o cuadrado, en maderas diferentes, presenta dimensiones variadas y alturas regulables, consintiendo máxima flexibilidad.

BRIO
Romano Marcato | 2001





brío coffee table

za system bump shape



brío coffee table **pass** lounge chair

add big lounge



brío coffee table **cut** lounge chair



brío coffee table



brio coffee table **kipu** pouf



Tavolo disponibile in altezze fisse o regolabile con piani rotondi o quadrati in varie misure e finiture. Base rivestita in acciaio inox finitura "tela di lino" con colonna in cromo satinato, o con base e colonna verniciate a polveri.









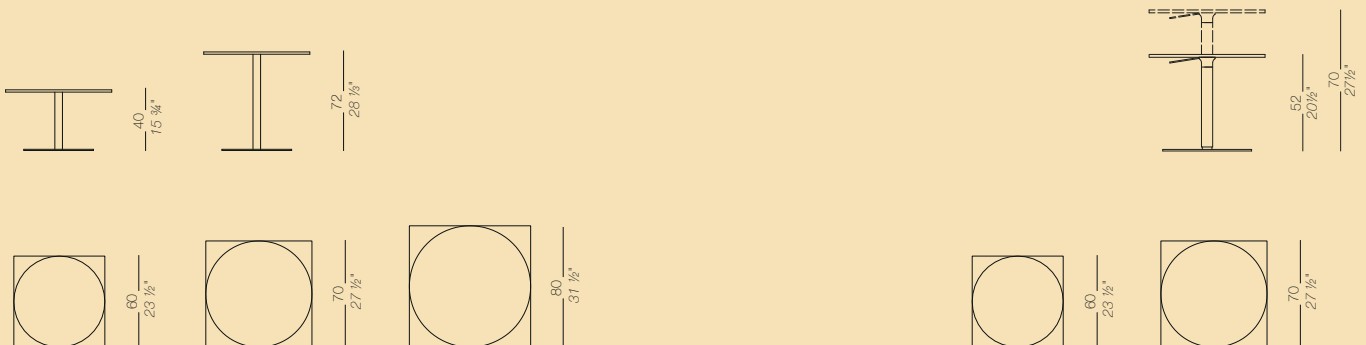



















Table in fix heights or height adjustable with tops in several dimensions and finishes. Round base with stainless steel "linen fabric" pattern and mat chromed column or entirely powder coated.

Tisch in verschiedenen Höhen, fix oder höhenverstellbar, mit Tischplatten in verschiedenen Ausführungen, rund oder quadratisch. Bodenplatte aus Edelstahl mit Leinenstruktur oder pulverlackiert und Säule mattverchromt oder pulverlackiert. Table disponible en

hauteurs fixes ou réglable avec plateau en plusieurs dimensions et finitions. Base en acier finition "toile de lin" et colonne chromée mat ou entièrement laqué.

Mesa disponible en alturas fija o regulable con encimeras redondas o cuadradas de diferentes tamaños y acabados. Base revestida en acero inoxidable con trama en "tela de lino" con columna cromada mate o base y columna lacadas a polvo.



 <p>Base acciaio inox tela di lino</p>	 <p>Base stainless steel linen-pattern</p>	 <p>Basis Edelstahl Leinenstruktur</p>	 <p>Base acier inox toile de lin</p>	 <p>Base acero inoxidable tejido de lino</p>
 <p><i>verniciata a polvere:</i> nero bianco</p>	 <p><i>powder coated:</i> black white</p>	 <p><i>pulverlackiert:</i> schwarz weiß</p>	 <p><i>laqué en poudre:</i> noir blanc</p>	 <p><i>lacado en polvo:</i> negro blanco</p>
 <p>Colonna cromo satinato</p>	 <p>Leg mat chromed</p>	 <p>Säule matt verchromt</p>	 <p>Colonne chromé mat</p>	 <p>Columna cromado mate</p>
 <p><i>verniciata a polvere:</i> nero bianco</p>	 <p><i>powder coated:</i> black white</p>	 <p><i>pulverlackiert:</i> schwarz weiß</p>	 <p><i>laqué en poudre:</i> noir blanc</p>	 <p><i>lacado en polvo:</i> negro blanco</p>
 <p>Piano laminato bianco HPL bianco HPL rovere sbiancato HPL Fenix® nero HPL Fenix® bianco</p>	 <p>Top white laminate white HPL blanched oak HPL black Fenix® HPL white Fenix® HPL</p>	 <p>Platte Laminat weiß HPL weiß HPL Eiche gebleicht HPL schwarz Fenix® HPL weiß Fenix®</p>	 <p>Plateau lamifié blanc HPL blanc HPL chêne blanchi HPL Fenix® noir HPL Fenix® blanc</p>	 <p>Encimera laminado blanco HPL blanco HPL roble blanqueado HPL Fenix® negro HPL Fenix® blanco</p>
 <p>rovere sbiancato rovere noce scuro nero poro aperto laccato bianco</p>	 <p>blanched oak oak stained dark-walnut black open pore white lacquered</p>	 <p>Eiche gebleicht Eiche dunkel nussbaum gebeizt schwarz gebeizt offenporig weiß lackiert</p>	 <p>chêne blanchi chêne teinté wengé noir pore ouvert laqué blanc</p>	 <p>roble blanqueado roble nogal oscuro negro poro abierto lacado blanco</p>

ZA è un sistema che si moltiplica e si riproduce all'infinito con elementi modulari di seduta curvi e lineari, che ricordano il corpo flessibile di un millepiedi. La forma sinuosa della seduta asseconda l'azione di sedersi, che può avvenire su entrambi i lati, offrendo quindi molte soluzioni di arredo che ben si adattano a diversi tipi di spazi: configurazioni circolari, lineari o a S.

La semplicità formale del disegno lascia appena intravedere il punto di contatto, un sostegno metallico a nastro che permette di accostare le sedute con un gioco compositivo.

ZA is a bench system repeating itself, endlessly, with modular units which has flowing lines, and adapts well to different kinds of spaces: round configurations, straight or "s" shaped. The metal frame is gently joined to the surface with the formal simplicity of its design forming a curved seat that can be used from either side.

Das Sitzsystem ZA lässt sich durch eine Kombination von geraden und gebogenen Sitzelementen unendlich fortsetzen und erinnert beinahe an einen Tausendfüßler. Die geschwungene Sitzfläche erleichtert das Sitzen und kann von beiden Seiten her genutzt werden. ZA bietet unendliche Kombinationsmöglichkeiten und kann damit an die unterschiedlichsten architektonischen Gegebenheiten angepasst werden: kreisförmige, gerade oder s-förmige Sitzgruppen sind möglich. Durch die schlichte Form verwischt sich der Übergang zwischen den einzelnen Elementen. Das Gestell ist ein einfaches Metallband, das eine spielerische Aneinanderreihung der Sitzelemente ermöglicht.

ZA est un système de bancs composé d'éléments courbes et d'autres linéaires, modulaires et flexibles qui peuvent se reproduire à l'infini, tel un mille-pattes. La forme courbée de l'assise permet de l'utiliser des deux cotés et favorise donc des solutions qui s'adaptent bien à différents types d'endroits: configurations circulaires, simples ou en "S". La simplicité formelle du dessin révèle à peine le point de contact, un support métallique en forme de ruban qui permet de juxtaposer les assises comme dans un jeu de construction.

ZA es un sistema que se multiplica y reproduce al infinito, con elementos modulares de asientos curvos y lineales, que recuerdan el cuerpo flexible de un milpiés. La forma sinuosa del asiento facilita la posibilidad de sentarse en ambos lados, ofreciendo muchas soluciones de decoración que se adaptan a diferentes tipos de espacios: configuraciones circulares, lineales o S. La simplicidad formal del diseño deja intuir apenas el punto de contacto, un soporte metálico a cinta que permite unir los asientos en un juego compositivo.

ZA SYSTEM

Shin & Tomoko Azumi | 2003





za system S_shape



brio coffee table kipu pouf za system bump shape





kipu pouf za system round shape



ZA SYSTEM

Shin & Tomoko Azumi | 2003

Sistema modulare di sedute con telaio in fusione d'alluminio lucido o verniciato a polveri. Disponibile con seduta in legno in varie finiture o rivestita in pelle. Tutti gli elementi possono essere facilmente collegati tra loro per creare combinazioni fluide o anelli per aree d'attesa, musei, scuole.

Seating modular system with die cast aluminium frame, powder coated or polished. Seat in wood or upholstered with leather. The units can be linked to create flowing lines and circular elements for waiting areas, museums and schools.

System aus modularen Sitzbänken mit Gestell aus poliertem oder pulverlackiertem Aluminium. Erhältlich mit Sitz aus Holz in verschiedenen Ausführungen oder lederbezogen. Alle Elemente können verbunden werden, um verschiedene Kompositionen herzustellen, die sich für Warteräume in Museen oder Schulen eignen.

Système de banquettes modulaires en fusion d'aluminium poli ou laqué. Assise en bois ou revêtue de peau. Toutes les unités peuvent être liées pour créer de longues lignes fluides ou des cercles destinés aux salles d'attente, musées, écoles.

Sistema modular de asientos con estructura en fusión de aluminio lucido o lacado a polvo. Disponible con asiento en varios acabados de madera o tapizado completamente en piel. Todos los elementos pueden ser fácilmente conectados, para crear combinaciones fluidas o anillos, para zonas de espera, museos, escuelas o centros comerciales.

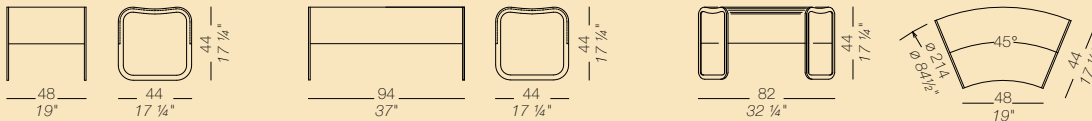

Struttura

Verniciata a polvere:
nero
bianco



Frame

Powder coated:
black
white

Gestell

Pulverlackiert:
schwarz
weiß

Structure

Laqué en poudre:
noir
blanc

Estructura

lacado en polvo:
negro
blanco

Sedute

rovere sbiancato
rovere noce scuro
nero poro aperto
laccato bianco



Seating

blanched oak
oak stained dark-walnut
black open pore
white lacquered

Sitzfläche

Eiche gebleicht
Eiche dunkel nussbaum gebeizt
schwarz gebeizt offenporig
weiß lackiert

Assise

chêne blanchi
chêne teinté wengé
noir pore ouvert
laqué blanc

Asiento

roble blanqueado
roble nogal oscuro
negro poro abierto
lacado blanco



pelle

soft-leather

Softleder

peau

piel

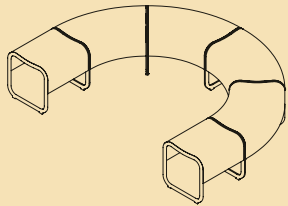

C_shape

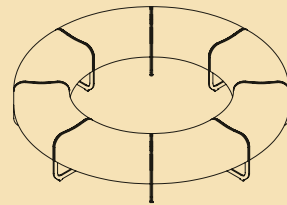

Round shape

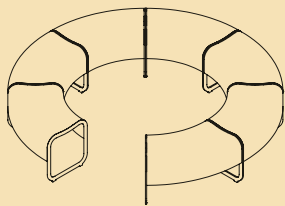

Round shape — open

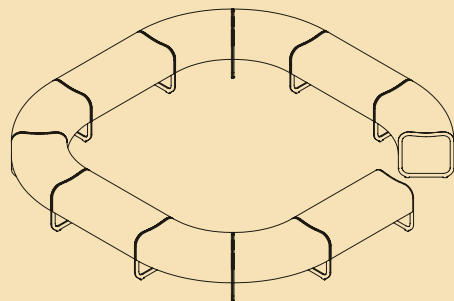

Square shape — open

ZA SYSTEM

Sample configurations

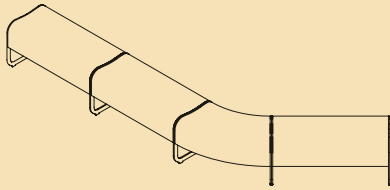

V_shape

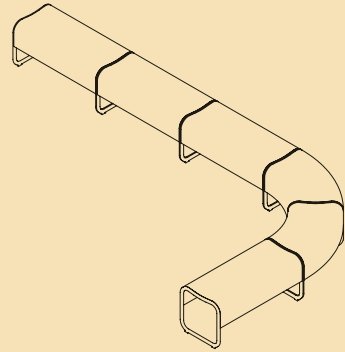

L_shape

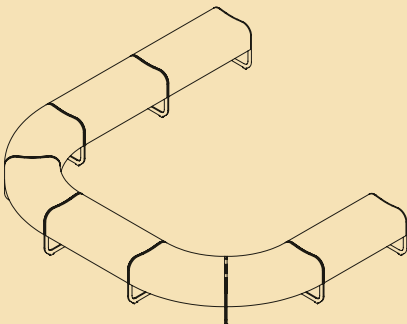

U_shape

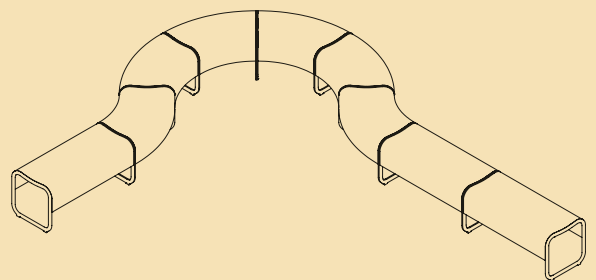

Corner shape

ZA SYSTEM

Sample configurations

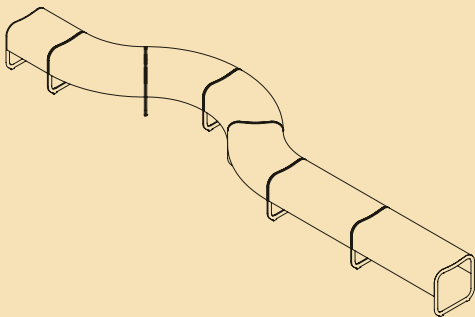

Bump shape

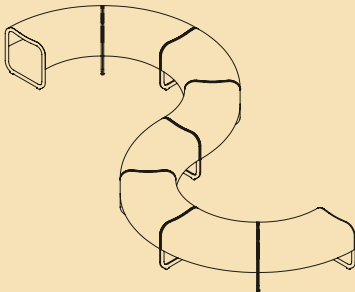

S_shape

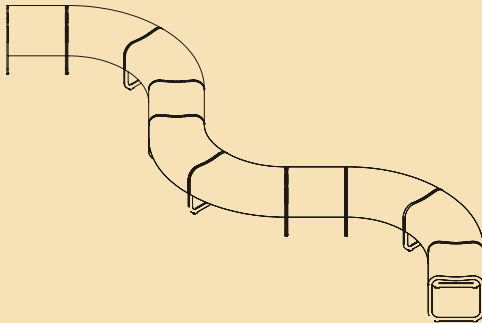

S_shape - double

Designers

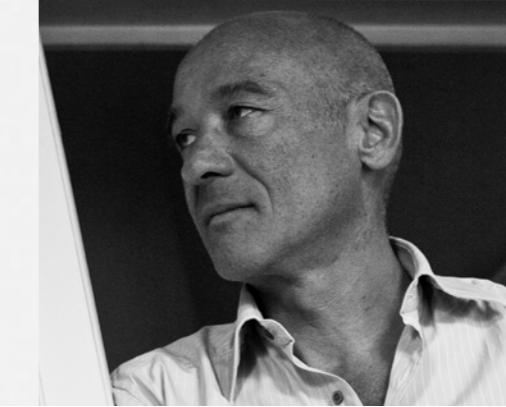

Anderssen & Voll

Anderssen & Voll is an Oslo based designstudio run by Torbjørn Anderssen (1976) and Espen Voll (1965). Torbjørn is graduated from The Bergen Academy of Art and Design and Espen is graduated from Oslo National Academy of the Arts. As cofounders of Norway Says in 2000, they were forerunners in a emerging international movement amongst young Norwegian designers. Since the startup of Anderssen & Voll in 2009, their work has spanned from textile design through tableware, lighting and furniture to electronics for some of Europe's most renowned international design Brands. Their collaborations include work for companies like Lapalma, Muuto, Wrong for Høy, Foscarini, Kvadrat, Erik Jørgensen and Filip Technologies. They also take great pride in working with some of the finest Norwegian traditional industry like Jøtul, Gudbrandsdalens Uldvarefabrik, Fjord Fiesta, Røros Tweed and LK Hjelte. Working with the very different industrial cultures spanning from the mountains of Norway to the plains of Veneto is a continuous source of inspiration. Their work has received numerous awards like Honorary Award for Design Excellence in Norway, Wallpaper Award, IF Award and the Torsten and Wanja Söderberg Prize.

Shin Azumi

Shin Azumi was born in Kobe, Japan in 1965. After finishing his MA at the Royal College of Art in 1994, he started working as a design unit 'AZUMI'. In 2005, he established his own office 'a studio' in London, and he moved his base back to Japan in Tokyo in 2016. Currently he is taking the professorship at Hosei University, faculty of engineering and design in Japan. The clients list of 'a studio' includes lapalma, Magis, Desalto, Fredericia, Tefal, Authentics and many other international brands. Shin Azumi's work has received numerous design awards in Europe and in Japan, amongst which the Blueprint 100% Design Award and "Product of the Year" of FX International Design Award. He also took part in the jury of numerous design awards such as, IF Design Award (DE). His works were acquired by many international museums such as Victoria & Albert Museum (UK), Stedelijk Museum (Holland), etc.

Tomoko Azumi

Tomoko Azumi (born in 1966, Hiroshima, Japan) is an interior and furniture designer based in London. She studied architecture and interior design at Kyoto City University of Art, worked in architectural studio in Tokyo, then moved to London in 1992. She finished a master course of Furniture Design at the Royal College of Art in 1995. After her activities as a partnership AZUMI (1995-2004), she started her own practice TNA Design Studio in East London in 2005. At TNA Design Studio, her main fields are furniture, lighting products, interior design and exhibition space design. She has been collaborating with international clients such as Benchmark Furniture (UK), Lapalma (Italy), Maxray (Japan), Röthlisberger (Switzerland) and Swarovski (Austria), as well as interior design for The Supreme Court of United Kingdom, shops for Harrys London and exhibition designs for the Crafts Council (UK). Her works are in several permanent collections include Victoria & Albert Museum and Geoffrey Museum in London and Stedelijk Museum (Netherlands). She has been a project teacher at the Design Products of Royal College of Art since 2005 and a research fellow at London Metropolitan University from 2006 to 2009. Also she is a member of jury for Good Design Award in Japan since 2006 and member of selection board for 100% Design London in 2010 and a member of jury for imm Design Award at the Cologne Furniture Fair on 2010 and 2011.

Romano Marcato

Born in Cadoneghe (Padova – Italy) in 1951. He got his degree in 1970 in mechanics at the Technical – Industrial Institute in Padova. From 1970 till 1978 he was in charge of planning high precision tools in an industry producing moulds for high-speed trimmer for electrical connections. He also planned automatic machines to fix the connections in the car industry, electronics and domestic appliances. In 1979, together with his brother Dario, he founded Lapalma and designed some of the products: he is head of the technical department and in charge of prototyping, engineering and industrialisation of products.

Francesco Rota

Francesco Rota, interior and product designer, was born in 1966 in Milan, where he lives and works. After graduating in industrial design at the Art Center College of Design in La Tour de Peilz (Switzerland), he opened his own studio in 1998 specialised in different fields of design: products, furniture, lighting, showrooms, offices, private homes and exhibitions. Over the years Francesco has collaborated with a number of widely recognised brands such as Bals Tokyo, Barilla, Diade, Fiat, Frag, John Richmond, Knoll International, Lapalma, Lema, Living Divani, L'Oreal Paris, Malo, Martini & Rossi, Mercedes Benz, Moroso, Paola Lenti, Oluce, Versus. Francesco was awarded three honourable mentions for the Compasso d'Oro with Linea, Island and ADD. ADD System was among the nominees in 2017. The products Kanji and Move were awarded The Good Design Awards in 2016, and Uptown in 2017. Same year Screen was awarded Wallpaper* Design Award and Agio won the Archiproducts Design Award. Francesco is a winner of the German Design Award with the products Move, ADD, Kanji while with Daydream he received a special mention in 2014; a winner of The Red Dot Design Award with ADD, Move and Kanji in 2016 and Red Dot Best of the Best with Uptown in 2017; winner of Interior Design Best of the Year 2014 Award with the product Cloud. In 2013 Francesco was a finalist for the Wallpaper Judges' Award in the section Designer of the Year and in 2015 he was selected among the Top 200 designers of the year by Architonic. From 2013 he is art director of Lapalma.

Hee Welling

Hee Welling (born 1974) is educated from the University of Art and Design Helsinki (Finland) and the Royal Danish Academy of Fine Arts – department of furniture design, from where he graduated, with a master degree in furniture design in 2003. He established his own studio in Copenhagen in 2003 and works within the fields of furniture-, interior- and industrial design. Among his clients is HAY, Erik Jørgensen, Fredericia, Lamnhults, Laufen and Lapalma. His work has been awarded several awards, including - the BoBedre design award (Denmark), the Good Design award (USA), the Danish Art foundation (Denmark), he has been nominated as Danish designer of the year in 2013 and 2014, and is listed on the Architonic Top 200 of popular designers and architects. Hee Welling's design has been exhibited at different fairs and museums around the world – e.g. Danish export exhibition – Tokyo, IOFF – New York, 100% design – London, Stockholm Furniture fair, IMM – Cologne, Maison&Objet - Paris and Salone del mobile – Milan. His work has been used for different international interior projects, such as the Oslo opera house (Norway), the Australian parliament, Google head office, Beats by Dre head office, Amazon head office, Danish national television and the Danish parliament. Besides his studio he had taught at the Royal Danish Academy of Fine Arts and the Danish Institute for Study abroad – DIS.

Finishes

Lapalma srl si riserva il diritto di apportare modifiche tecniche e dimensionali e di introdurre miglioramenti che potrebbero cambiare l'estetica dei prodotti presentati in catalogo. I riferimenti colore stampati non sono vincolanti.

Lapalma srl reserves the right to alter the technical and dimensional specifications given in this publication and to introduce improvements that may change the aesthetics of the products shown in this catalogue. The printed colours hues are not binding.

Lapalma srl behält sich das Recht vor, jederzeit Veränderungen an den technischen Details und den Dimensionen der Produkte vorzunehmen und Verbesserungen einzuführen, die die Ästhetik der Produkte verändern können. Die Farbtöne der Abbildungen können von den tatsächlichen Farben der Produkte abweichen.

Lapalma srl se réserve le droit d'apporter des modifications techniques et de dimensions ainsi que d'introduire des améliorations qui peuvent changer l'esthétique des produits présentés. Les tonalités imprimées n'engage pas la société.

Lapalma srl se reserva el derecho de cambiar tamanos y especificaciones técnicas de los productos listados en esta publicación, así como el de introducir mejoras que puedan cambiar la estética de los mismos. Por favor tengan en cuenta que los colores de los tejidos mostrados en fotografía no son totalmente fidedignos.

Cat C - Hallingdal 65 KVADRAT

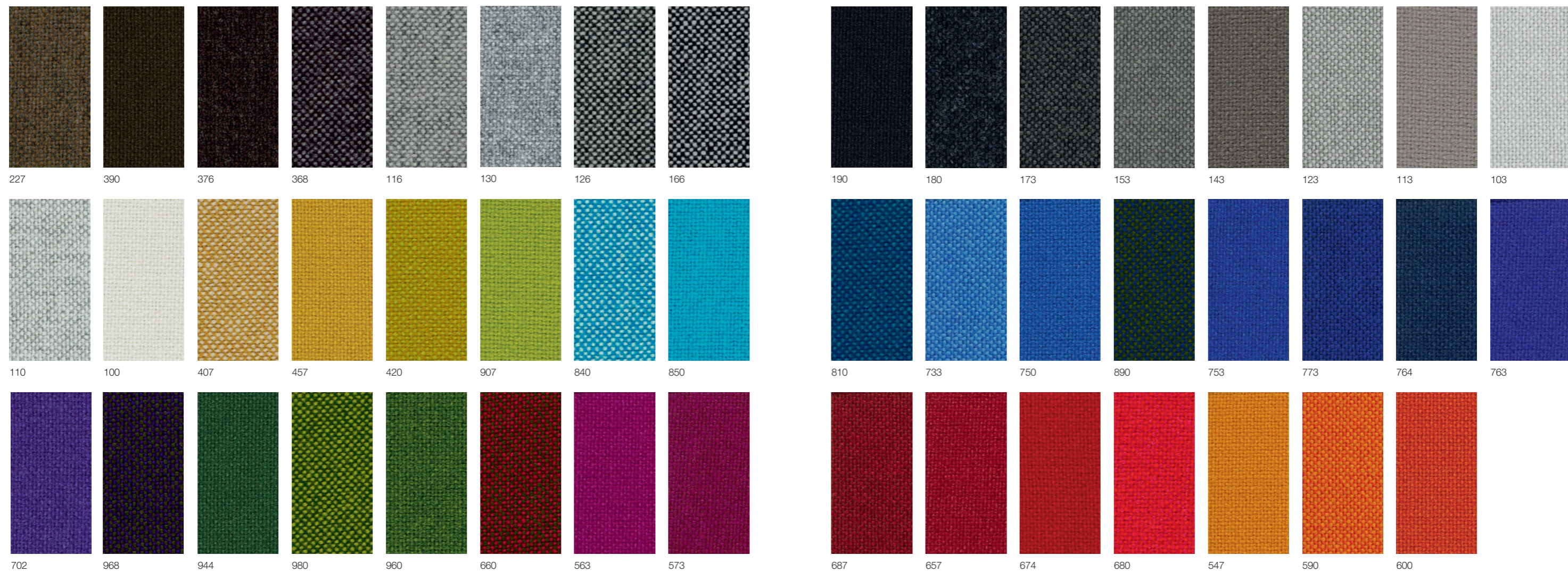

Cat C - Canvas 2 KVADRAT



114 224 244 264 174 154 134 124

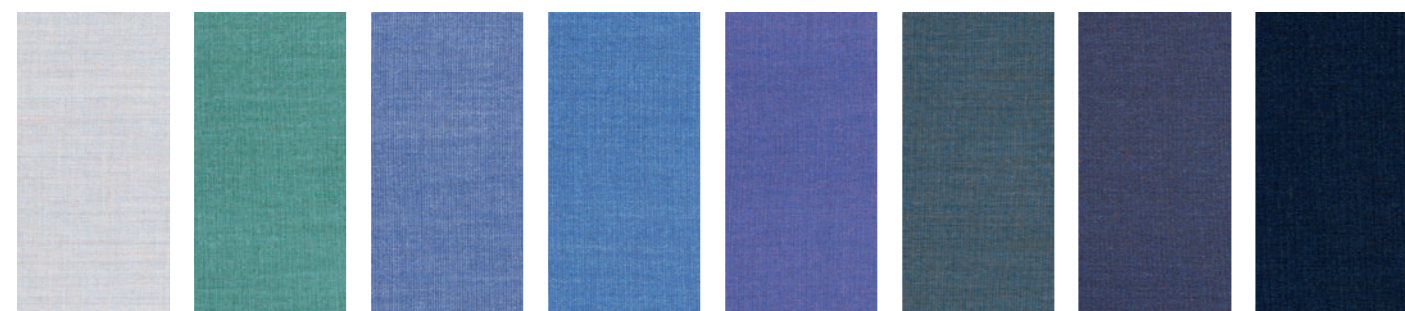

716 836 726 746 666 734 786 794



654 576 644 614 566 546 556 454



216 414 446 926 946 954 964 424



684 764 854 996 984 364 674 694

Cat D - Steelcut Trio 3 KVADRAT

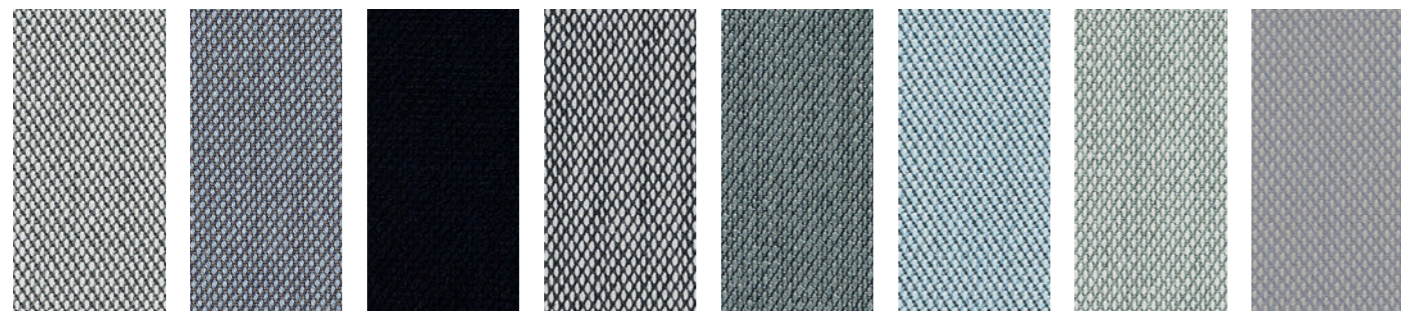

133 176 195 124 153 713 113 105

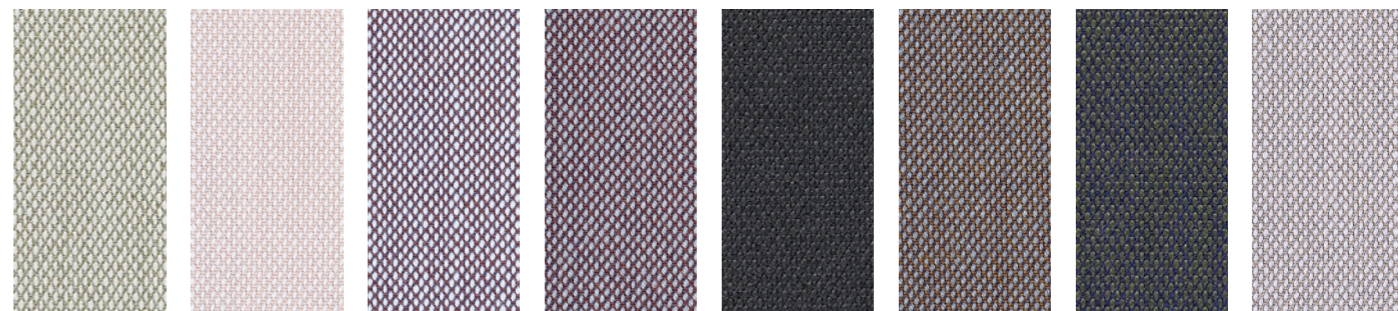

213 226 336 276 383 376 283 246

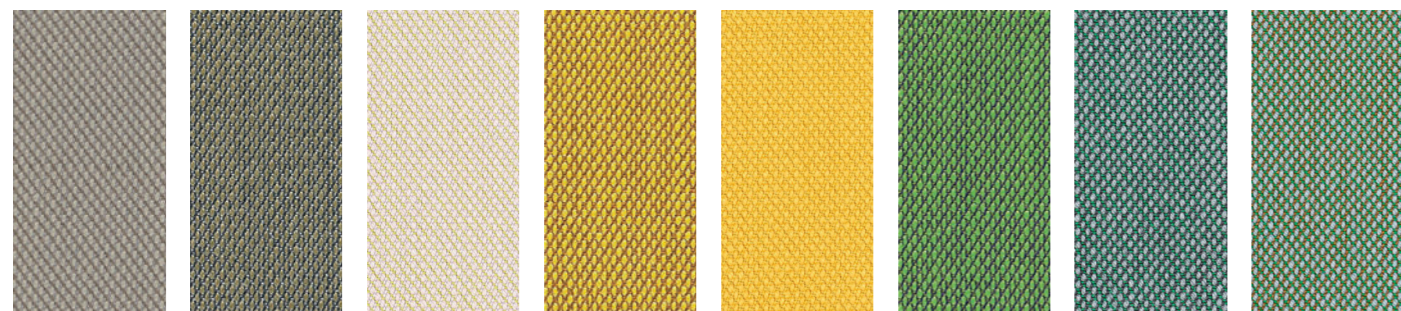

205 253 236 453 446 953 966 946

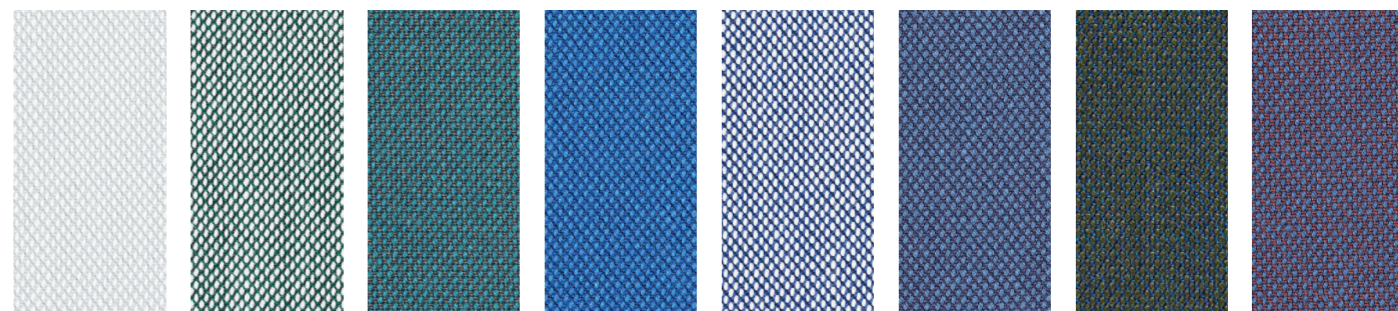

906 916 996 746 716 796 883 776

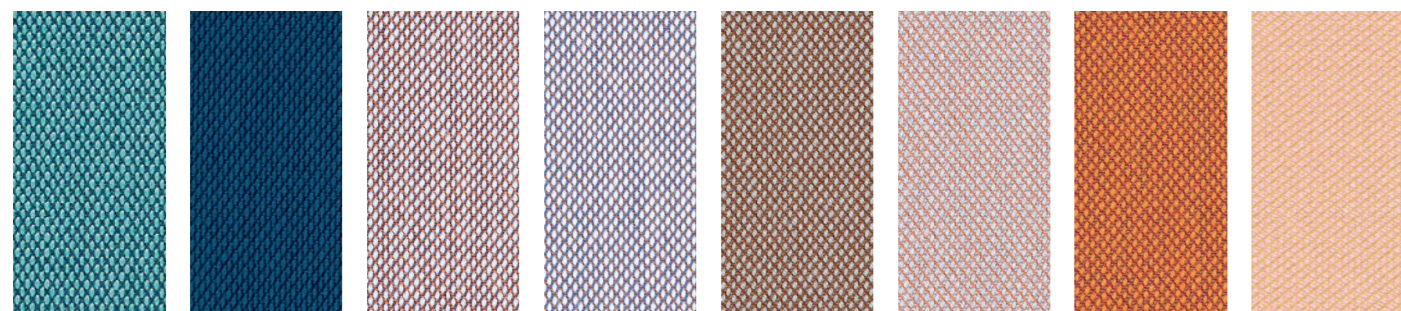

983 865 416 806 476 426 576 506

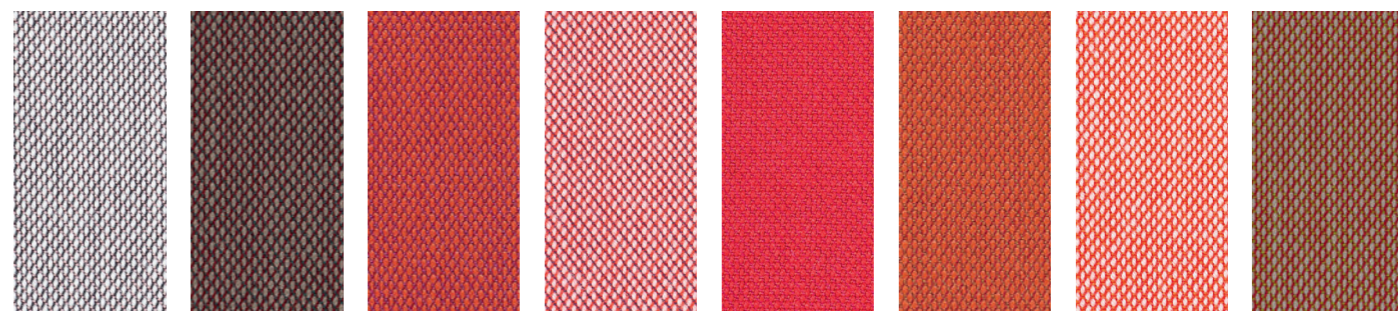

616 645 553 636 666 533 526 515

Cat C - Remix 2 KVADRAT



643 662 632 612 223 233 852 873



692 783 682 773 753 733 823 672



123 133 923 933 982 912 942 543

tessuto / fabric / Stoff / tissu / tejer

Cat C - Clara 2 KVADRAT



384 388 277 273 248 244 188 184

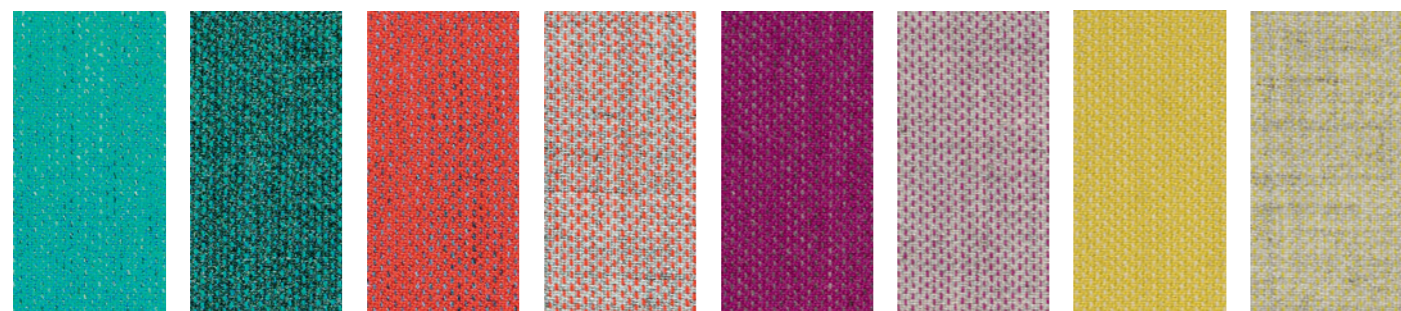

888 884 548 544 647 643 427 423

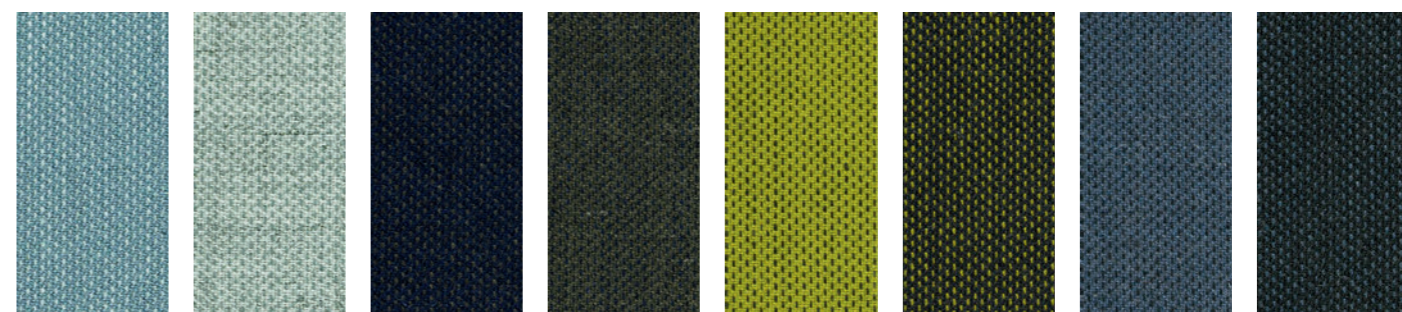

148 144 797 793 937 933 983 987

Cat C - Fiord KVADRAT

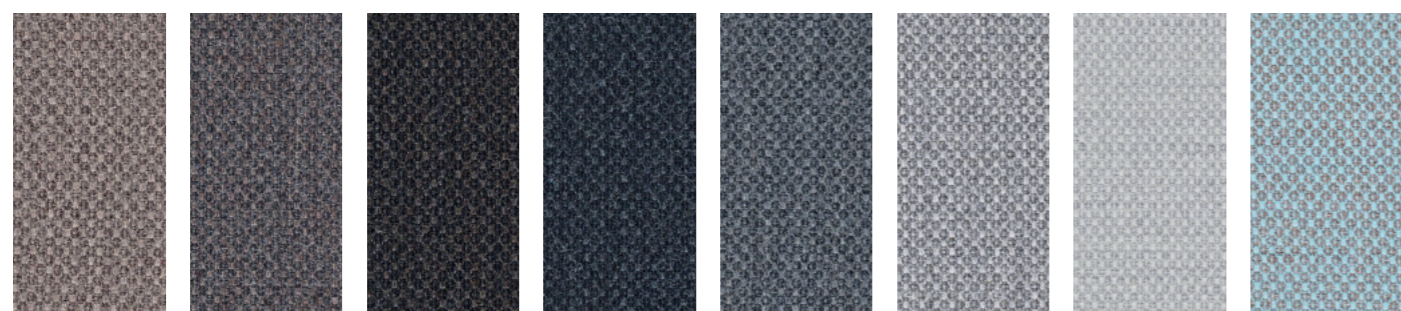

271 371 391 191 171 151 101 821

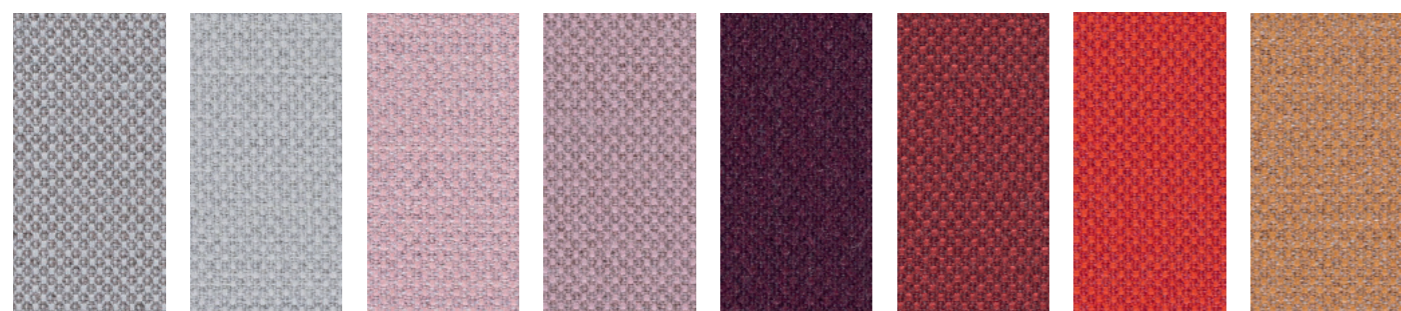

251 121 521 551 591 581 571 451

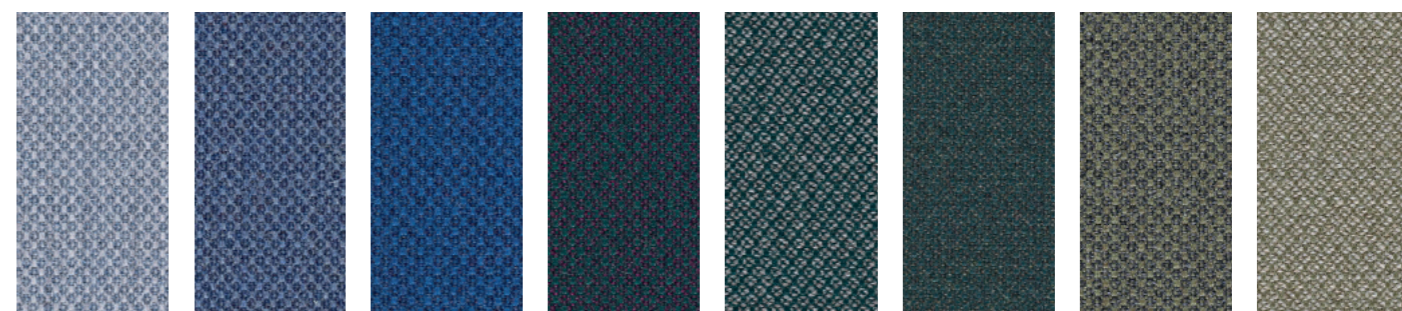

751 771 791 981 971 991 961 951

tessuto / fabric / Stoff / tissu / tejer

Cat D - Divina MD KVADRAT



193 353 343 363 453 213 913 943



743 753 683 633 653 613 203 433

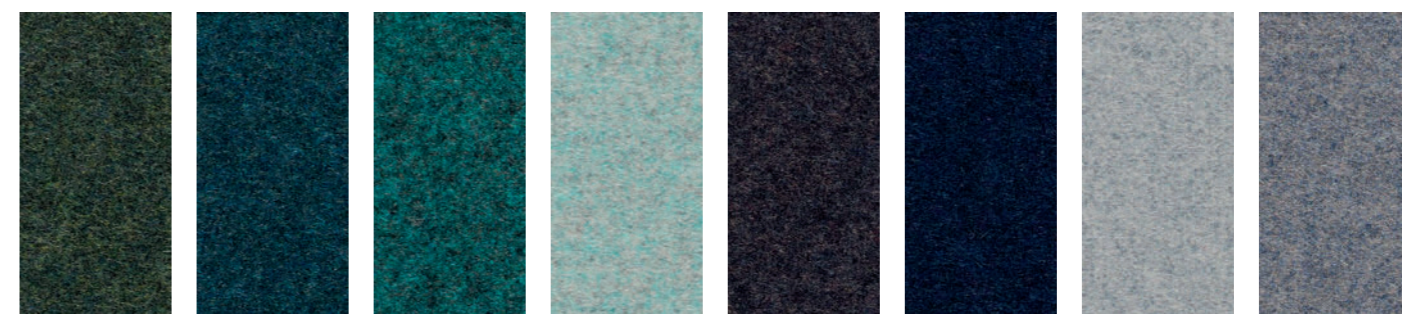

973 873 843 813 293 783 713 733

Cat D - Divina Melange 2 KVADRAT

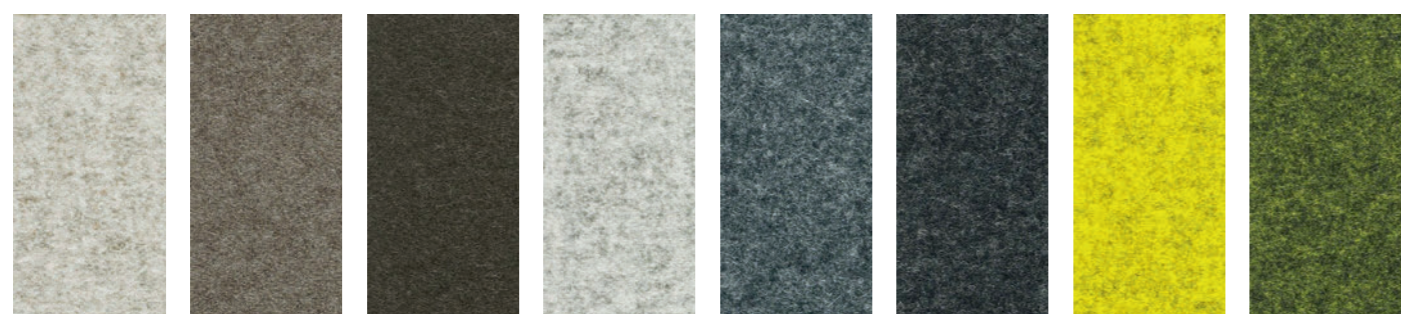

220 260 280 120 170 180 421 471

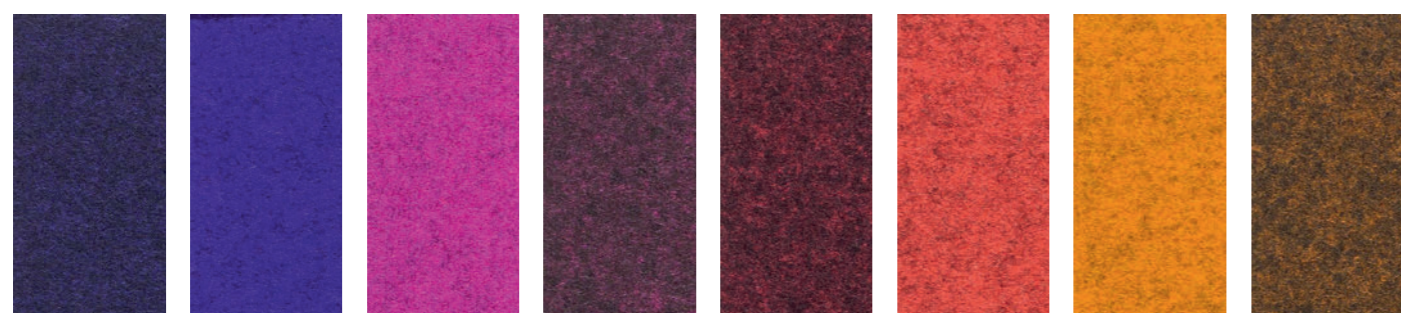

681 631 620 671 581 531 521 571

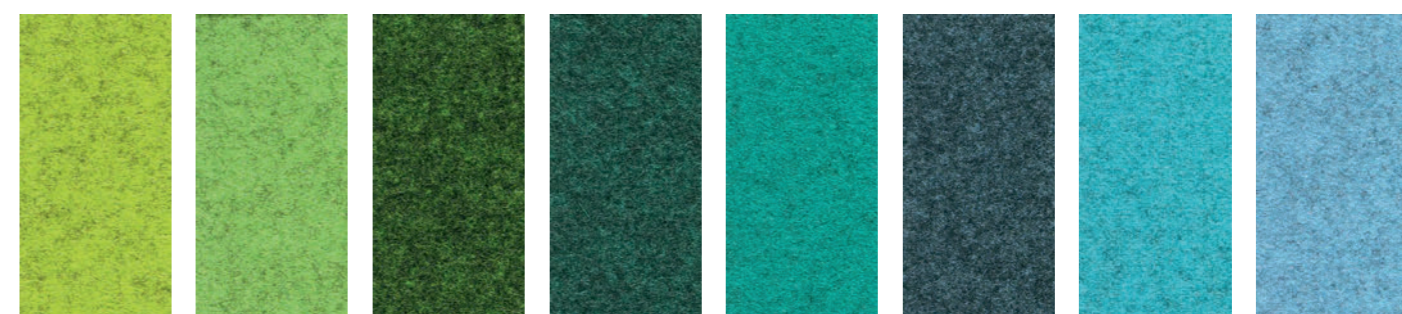

931 920 971 871 821 771 721 731

Cat C - Tonica 2 KVADRAT

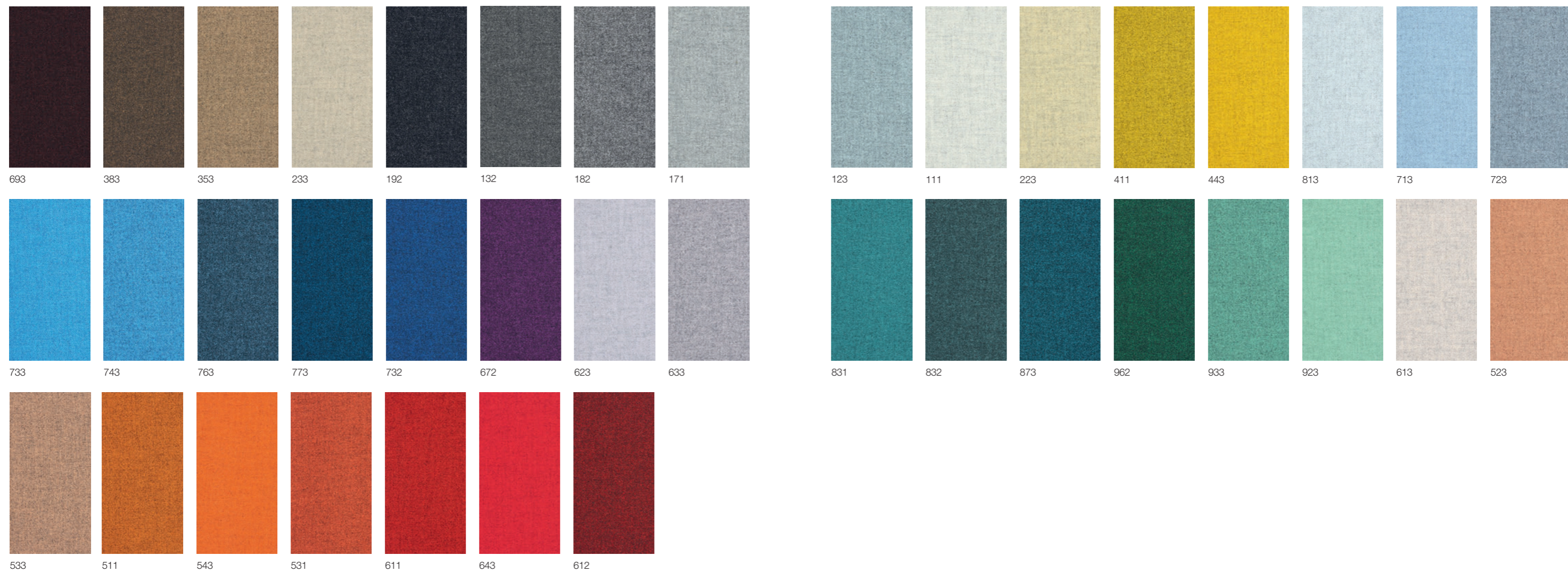

Cat A - Medley GABRIEL



Cat B - Swing GABRIEL

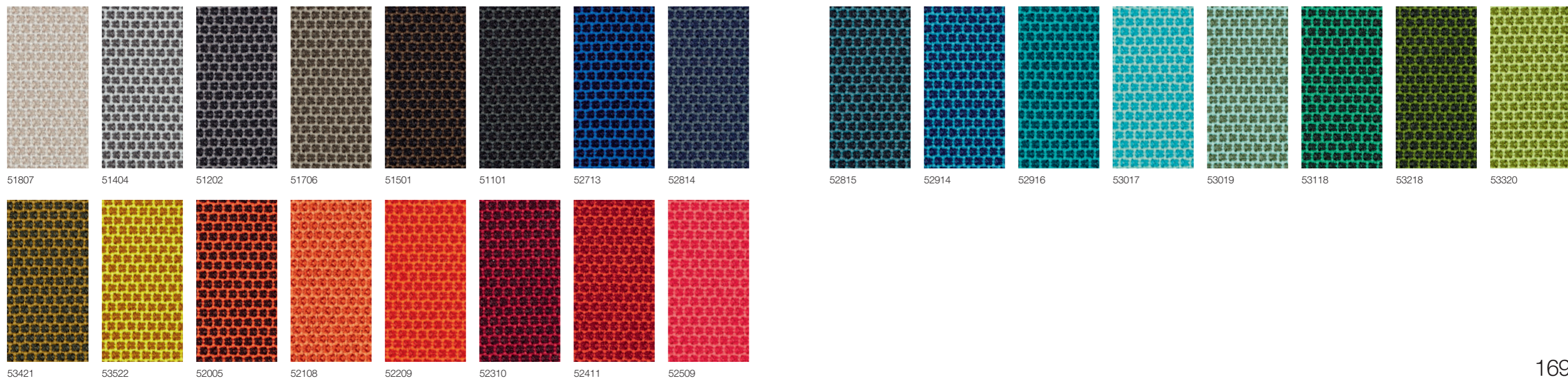

Cat A - Maya FIDIVI

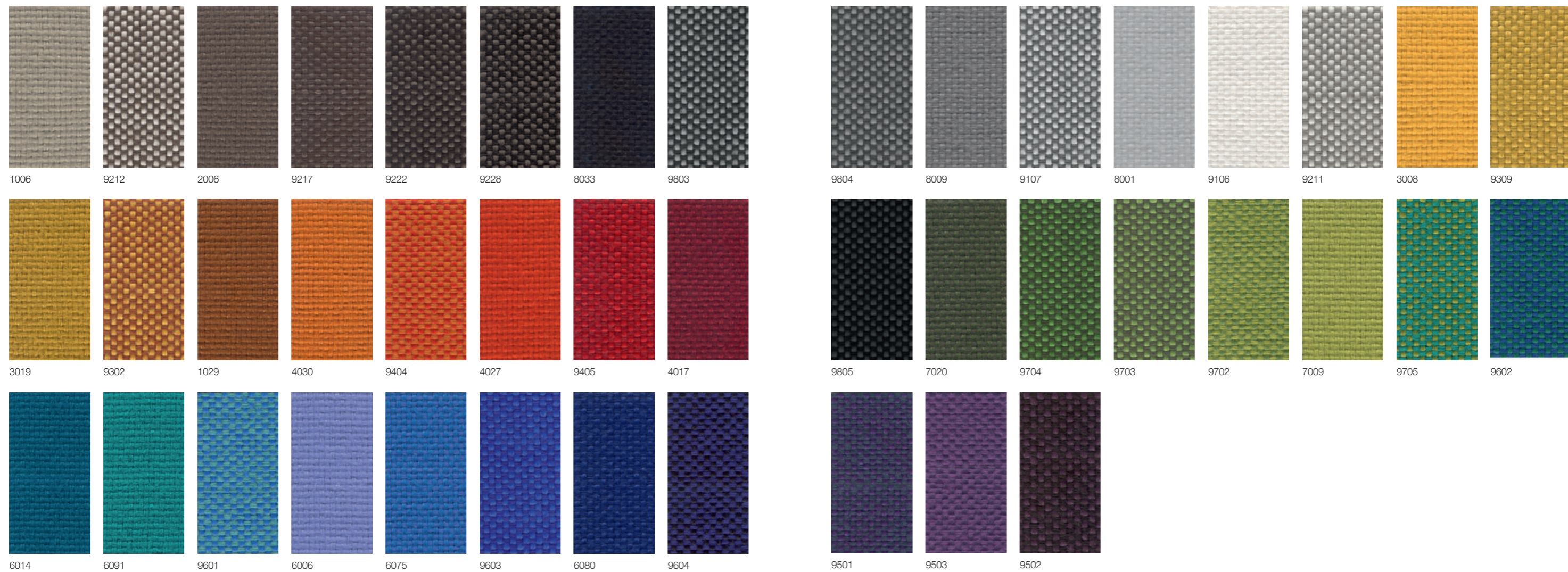

Cat A - Jet FIDIVI

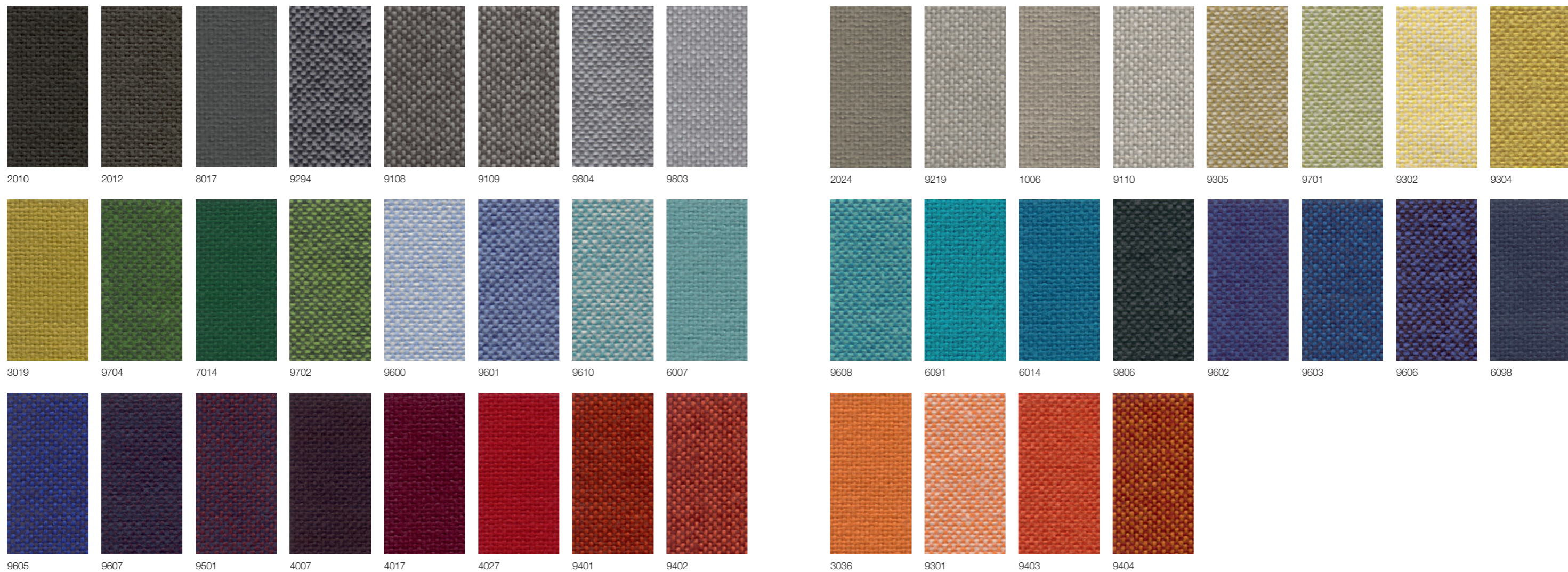

Cat B - Laser J Flash FIDIVI

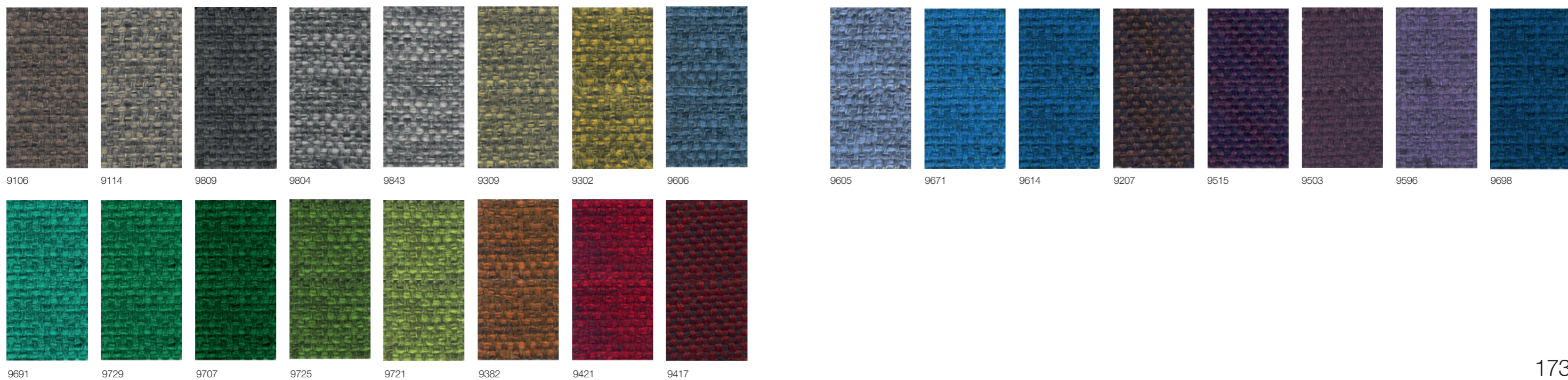

eco pelle / eco-leather / Kunstleder / simil cuir / ecopiel

Cat A - GRIMM FR MP

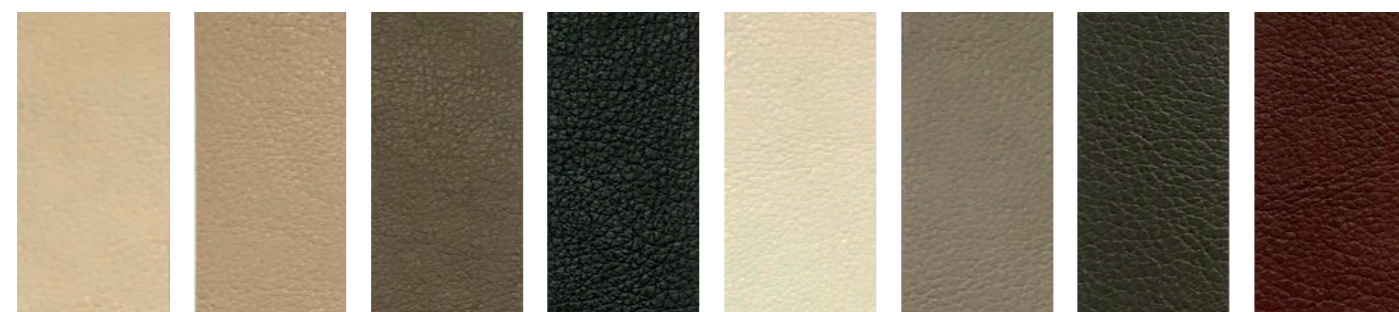

1C8 4P2 4H8 5P4 101 2PB 2C7 5H3



5PE 2PA 2DJ 901 3CS 7P5 7FC 7EM

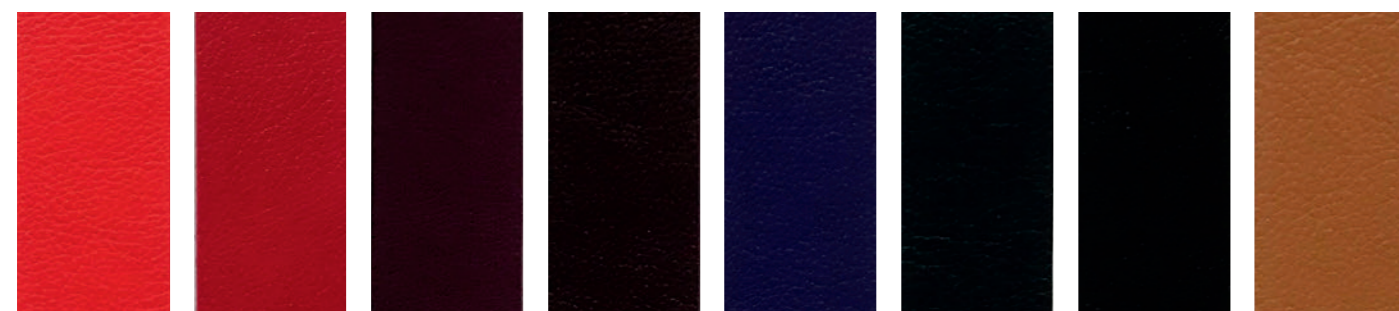

6VZ 6P1 6KH 6P7 8P8 8H4 8P9 5P3

pelle / soft-leather / Softleder / peau / piel



P1 P10 P4 P3 P7 P9 P2

laccati / lacquered / lackiert / laqué / lacado

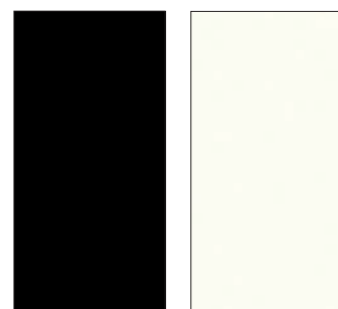

laccato nero
black lacquered
schwarz lackiert
laqué noir
lacado negro

laccato bianco
white lacquered
weiß lackiert
laqué blanc
lacado blanco

laminati / laminate / Laminat / lamifié / laminado

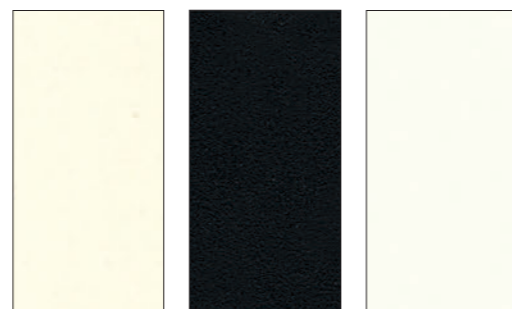

FW fenix 9/10
laminato bianco
white laminate
Laminat weiß
lamifié blanc
laminado blanco

FN fenix 9/10
laminato nero
black laminate
Laminat schwarz
lamifié noir
laminado negro

406 abet 9/10
laminato bianco
white laminate
Laminat weiß
lamifié blanc
laminado blanco

verniciature a polvere / powder coating / pulverlackiert / laqué en poudre / lacadura en polvo

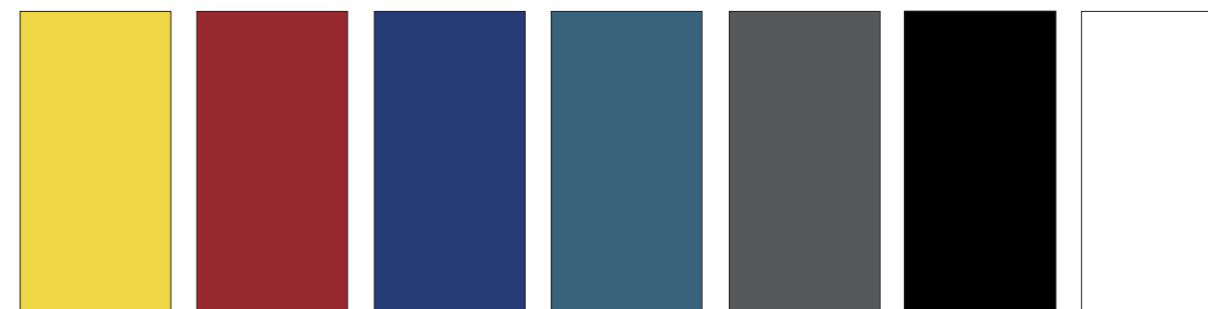

02
senape

12
rubino

14
blu notte

16
verde petrolio

18
grigio medio

05
nero
black
schwarz
noir
negro

03
bianco
white
weiß
blanc
blanco

HPL 10 mm

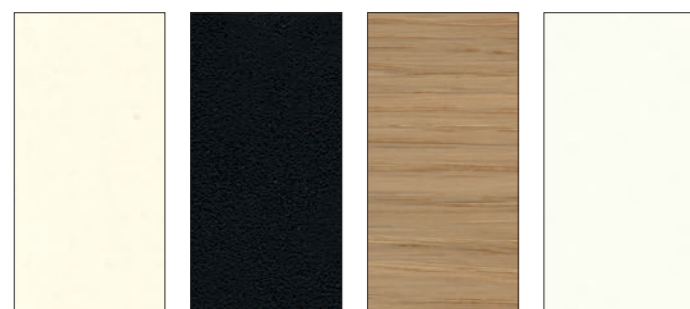

HFW
fenix bianco
white fenix
weiß fenix
fenix blanc
fenix blanco

HFN
fenix nero
black fenix
schwarz fenix
fenix noir
fenix negro

HVS
rovere
oak
Eiche
chêne
roble

H406
laminato bianco
white laminate
Laminat weiß
lamifié blanc
laminado blanco

metalli / metal / Metall / metal / metal

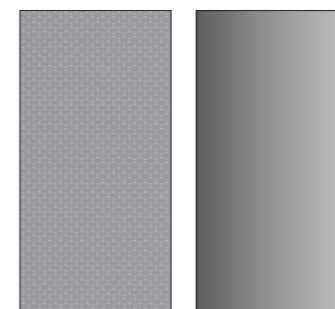

acciaio inox tela di lino
stainless steel linen-pattern
Edelstahl leinenstruktur
acier inox toile de lin
acero inoxidable tela de lin

25
cromo satinato
mat chromed
matt verchromt
chromé mat
cromado mate

legno / wood / Holz / bois / maderá

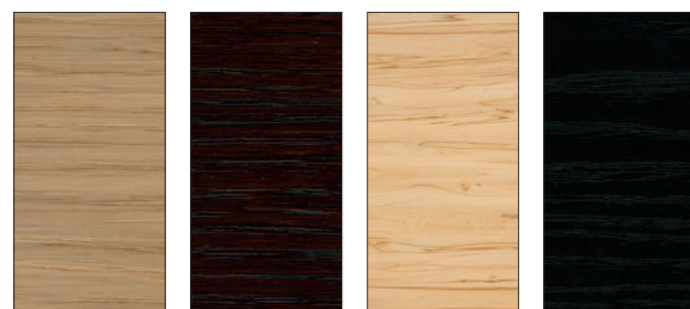

VS
rovere sbiancato
blanched oak
Eiche gebleicht
chêne blanchi
roble blanheado

VL
rovere noce
oak dark walnut
Eiche dunkel nußbaum
chêne teinté wengé
roble nogal

FR
frassino naturale
natural ash
Esche natur
frêne naturel
fresno natural

NO
nero poro aperto
black open pore
Eiche schwarz gebeizt
noir pore ouvert
negro poro abierto

marmo / marble / Marmor / marbre / mármol cemento / concrete / Beton / béton / cemento



bianco Carrara
white Carrara
Carrara-Marmor
blanc Carrara
blanco Carrara

nero Marquinia
black Marquinia
Marquinia-Marmor
noir Marquinia
negro Marquinia

cemento
concrete
Beton
béton
cemento

art direction

Francesco Rota

graphic design concept

Francesco Rota

photoAdriano Brusaferrì, Beppe Brancato,
Bianca Puleo, Daniele Gobbin,
Frank Schoepgens, Stefania Giorgi**styling**Martina Sanzarello
Sissi Valassina**styling assistant**

Giovanna Baseggio

postproduction

Studio Adna

text

Francesca Acerboni

layoutMatteo Astolfi
Studio Francesco Rota**printed by**

Grafiche Antiga

thanks toAlessi
Artemide
Axo Light
Aytm
Cc-tapis
FontanaArte
littala
Il Coccio Design
Incipit
Kasthall
Mhway
Mm Lampadari
Panasonic
Paola C.
Paola Paronetto
Pijama
Scandola Marmi
The Fenz
Zafferano

Certified ISO-9001 ISO-14001

**Lapalma s.r.l.**via Majorana 26
35010 Cadoneghe PD
Italy
T +39 049 702788
F +39 049 700889
info@lapalma.it
www.lapalma.it